

Introduction - Geometry

The following released test questions are taken from the Geometry Standards Test. This test is one of the California Standards Tests administered as part of the Standardized Testing and Reporting (STAR) Program under policies set by the State Board of Education.

All questions on the California Standards Tests are evaluated by committees of content experts, including teachers and administrators, to ensure their appropriateness for measuring the California academic content standards in Geometry. In addition to content, all items are reviewed and approved to ensure their adherence to the principles of fairness and to ensure no bias exists with respect to characteristics such as gender, ethnicity, and language.

This document contains released test questions from the California Standards Test forms in 2003, 2004, 2005, 2006, 2007, and 2008. First on the pages that follow are lists of the standards assessed on the Geometry Test. Next are released test questions. Following the questions is a table that gives the correct answer for each question, the content standard that each question is measuring, and the year each question last appeared on the test.

The following table lists each reporting cluster, the number of items that appear on the exam, and the number of released test questions that appear in this document. Some of the released test questions for Geometry are the same test questions found in different combinations on the Integrated Mathematics 1, 2, and 3 California Standards Tests and the Summative High School Mathematics California Standards Test.

REPORTING CLUSTER	NUMBER OF QUESTIONS ON EXAM	NUMBER OF RELEASED TEST QUESTIONS
Logic and Geometric Proofs	23	32
Volume and Area Formulas	11	17
Angle Relationships, Constructions, and Lines	16	24
Trigonometry	15	23
TOTAL	65	96

In selecting test questions for release, three criteria are used: (1) the questions adequately cover a selection of the academic content standards assessed on the Geometry Test; (2) the questions demonstrate a range of difficulty; and (3) the questions present a variety of ways standards can be assessed. These released test questions do not reflect all of the ways the standards may be assessed. Released test questions will not appear on future tests.

For more information about the California Standards Tests, visit the California Department of Education's Web site at <http://www.cde.ca.gov/ta/tg/sr/resources.asp>.

Geometry

Released Test Questions

1 Which of the following best describes deductive reasoning?

- A using logic to draw conclusions based on accepted statements
- B accepting the meaning of a term without definition
- C defining mathematical terms to correspond with physical objects
- D inferring a general truth by examining a number of specific examples

CSG00185

2 In the diagram below, $\angle 1 \cong \angle 4$.

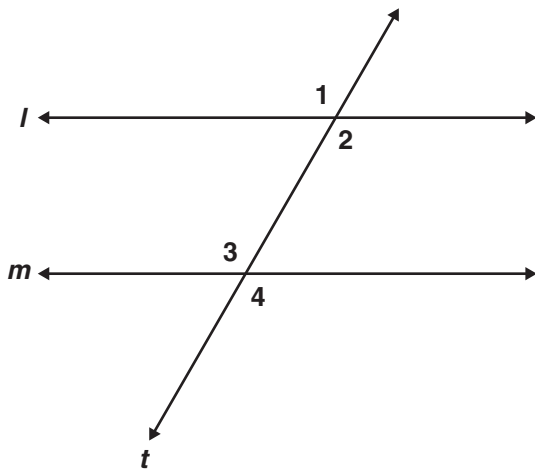

Which of the following conclusions does *not* have to be true?

- A $\angle 3$ and $\angle 4$ are supplementary angles.
- B Line l is parallel to line m .
- C $\angle 1 \cong \angle 3$
- D $\angle 2 \cong \angle 3$

CSG10066

3 Consider the arguments below.

- I. Every multiple of 4 is even. 376 is a multiple of 4. Therefore, 376 is even.
- II. A number can be written as a repeating decimal if it is rational. Pi cannot be written as a repeating decimal. Therefore, pi is not rational.

Which one(s), if any, use deductive reasoning?

- A I only
- B II only
- C both I and II
- D neither I nor II

CSG00552

4 Theorem: A triangle has at most one obtuse angle.

Eduardo is proving the theorem above by contradiction. He began by assuming that in $\triangle ABC$, $\angle A$ and $\angle B$ are both obtuse. Which theorem will Eduardo use to reach a contradiction?

- A If two angles of a triangle are equal, the sides opposite the angles are equal.
- B If two supplementary angles are equal, the angles each measure 90° .
- C The largest angle in a triangle is opposite the longest side.
- D The sum of the measures of the angles of a triangle is 180° .

CSG00025

- 5 Use the proof to answer the question below.

Given: $\overline{AB} \cong \overline{BC}$; D is the midpoint of \overline{AC}

Prove: $\triangle ABD \cong \triangle CBD$

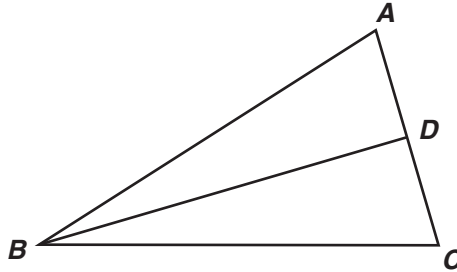

<u>Statement</u>	<u>Reason</u>
1. $\overline{AB} \cong \overline{BC}$; D is the midpoint of \overline{AC}	1. Given
2. $\overline{AD} \cong \overline{CD}$	2. Definition of Midpoint
3. $\overline{BD} \cong \overline{BD}$	3. Reflexive Property
4. $\triangle ABD \cong \triangle CBD$	4. ?

What reason can be used to prove that the triangles are congruent?

- A AAS
- B ASA
- C SAS
- D SSS

CSG10068

Geometry

Released Test Questions

- 6 In the figure below, $AB > BC$.

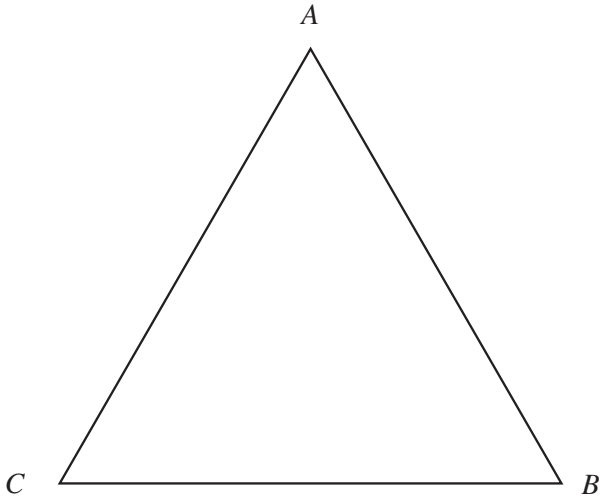

If we assume that $m\angle A = m\angle C$, it follows that $AB = BC$. This contradicts the given statement that $AB > BC$. What conclusion can be drawn from this contradiction?

- A $m\angle A = m\angle B$
- B $m\angle A \neq m\angle B$
- C $m\angle A = m\angle C$
- D $m\angle A \neq m\angle C$

CSG00524

- 7 Use the proof to answer the question below.

Given: $\angle 2 \cong \angle 3$

Prove: $\angle 1 \cong \angle 4$

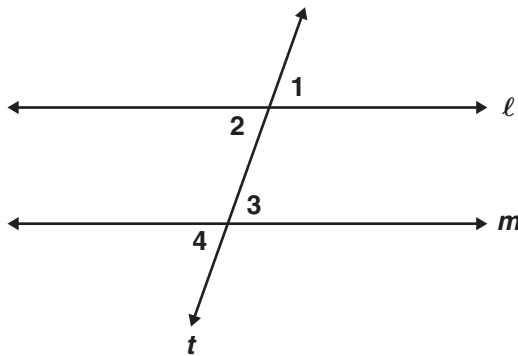

<u>Statement</u>	<u>Reason</u>
1. $\angle 2 \cong \angle 3$	1. Given
2. $\angle 1 \cong \angle 2; \angle 3 \cong \angle 4$	2. ?
3. $\angle 1 \cong \angle 4$	3. Transitive Property

What reason can be used to justify statement 2?

- A Complements of congruent angles are congruent.
- B Vertical angles are congruent.
- C Supplements of congruent angles are congruent.
- D Corresponding angles are congruent.

CSG10069

Geometry

Released Test Questions

- 8 “Two lines in a plane always intersect in exactly one point.”

Which of the following best describes a counterexample to the assertion above?

- A coplanar lines
- B parallel lines
- C perpendicular lines
- D intersecting lines

CSG00320

- 9 Which figure can serve as a counterexample to the conjecture below?

If one pair of opposite sides of a quadrilateral is parallel, then the quadrilateral is a parallelogram.

- A rectangle
- B rhombus
- C square
- D trapezoid

CSG10194

- 10 Given: $TRAP$ is an isosceles trapezoid with diagonals \overline{RP} and \overline{TA} . Which of the following *must* be true?

- A $\overline{RP} \perp \overline{TA}$
- B $\overline{RP} \parallel \overline{TA}$
- C $\overline{RP} \cong \overline{TA}$
- D \overline{RP} bisects \overline{TA}

CSG00260

- 11 A conditional statement is shown below.

If a quadrilateral has perpendicular diagonals, then it is a rhombus.

Which of the following is a counterexample to the statement above?

A



C

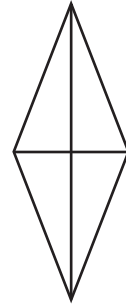

B

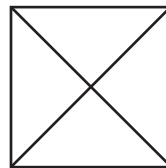

D

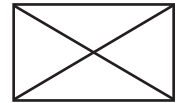

CSG20216

- 12** Students in a class rewrote theorems in their own words. One student wrote the following statement.

The area of a parallelogram is the product of any base (b) and any height (h).

Which figure shows a counterexample to prove the statement *false*?

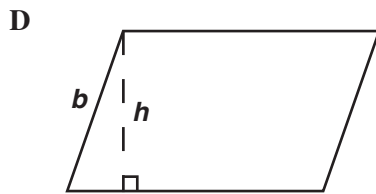
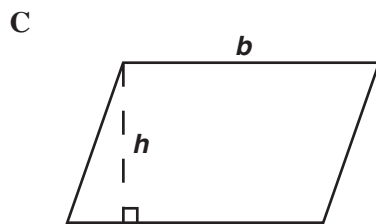
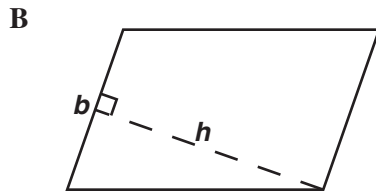
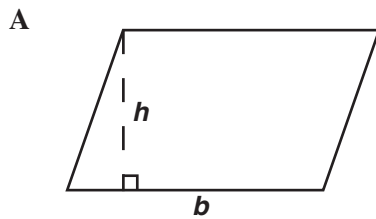

CSG10102

- 13** Which triangles must be similar?

- A two obtuse triangles
- B two scalene triangles with congruent bases
- C two right triangles
- D two isosceles triangles with congruent vertex angles

CSG00578

- 14** Which of the following facts would be sufficient to prove that triangles ABC and DBE are similar?

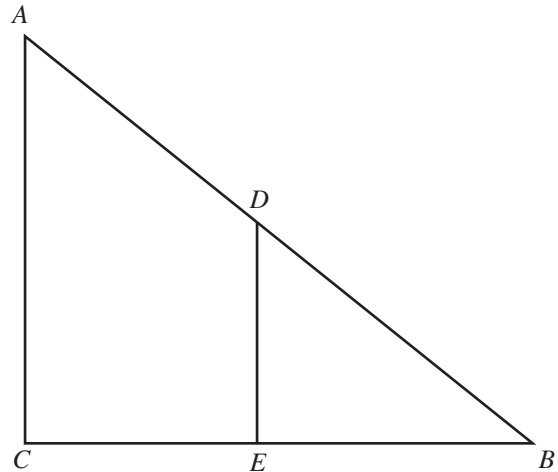

- A \overline{CE} and \overline{BE} are congruent.
- B $\angle ACE$ is a right angle.
- C \overline{AC} and \overline{DE} are parallel.
- D $\angle A$ and $\angle B$ are congruent.

CSG00544

Geometry

Released Test Questions

- 15 Parallelogram $ABCD$ is shown below.

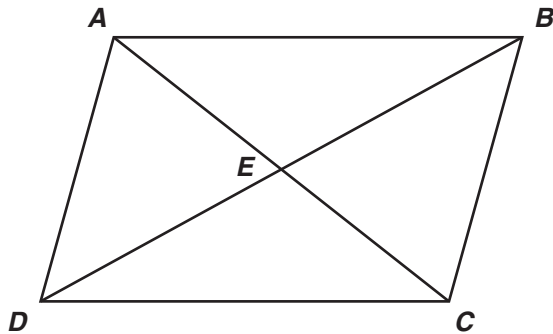

Which pair of triangles can be established to be congruent to prove that $\angle DAB \cong \angle BCD$?

- A $\triangle ADC$ and $\triangle BCD$
- B $\triangle AED$ and $\triangle BEC$
- C $\triangle DAB$ and $\triangle BCD$
- D $\triangle DEC$ and $\triangle BEA$

CSG10146

- 16 If $\triangle ABC$ and $\triangle XYZ$ are two triangles such that $\frac{AB}{XY} = \frac{BC}{YZ}$, which of the following would be sufficient to prove the triangles are similar?

- A $\angle A \cong \angle X$
- B $\angle B \cong \angle Y$
- C $\angle C \cong \angle Z$
- D $\angle X \cong \angle Y$

CSG10218

- 17 In parallelogram $FGHI$, diagonals \overline{IG} and \overline{FH} are drawn and intersect at point M . Which of the following statements *must* be true?

- A $\triangle FGI$ must be an obtuse triangle.
- B $\triangle HIG$ must be an acute triangle.
- C $\triangle FMG$ must be congruent to $\triangle HMG$.
- D $\triangle GMH$ must be congruent to $\triangle IMF$.

CSG00559

- 18 Which of the following *best* describes the triangles shown below?

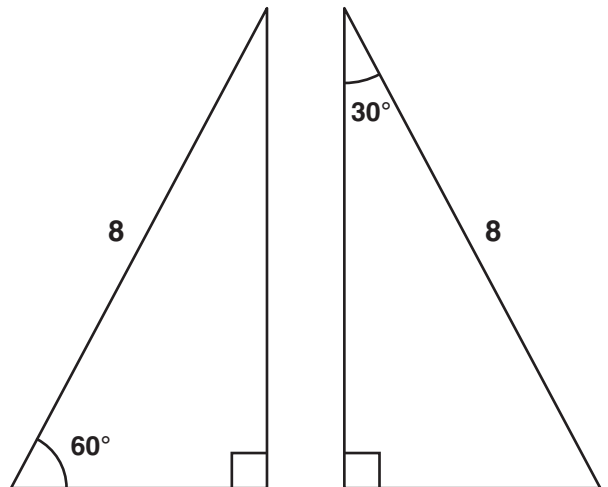

- A both similar and congruent
- B similar but not congruent
- C congruent but not similar
- D neither similar nor congruent

CSG00478

Released Test Questions

Geometry

- 19 Which of the following statements must be true if $\triangle GHI \sim \triangle JKL$?

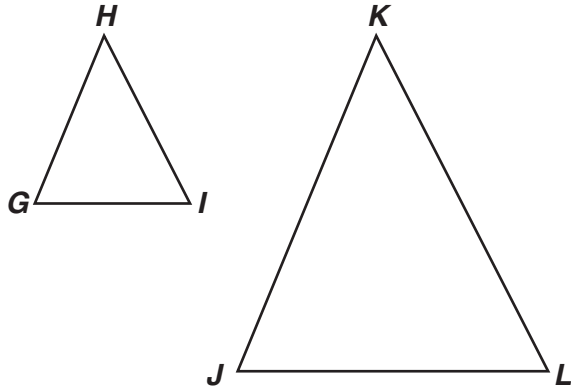

- A The two triangles must be scalene.
 B The two triangles must have exactly one acute angle.
 C At least one of the sides of the two triangles must be parallel.
 D The corresponding sides of the two triangles must be proportional.

CSG20074

- 20 Which method listed below could *not* be used to prove that two triangles are congruent?

- A Prove all three sets of corresponding sides congruent.
 B Prove all three sets of corresponding angles congruent.
 C Prove that two sides and an included angle of one triangle are congruent to two sides and an included angle of the other triangle.
 D Prove that two angles and an included side of one triangle are congruent to two angles and an included side of the other triangle.

CSG10151

- 21 In the figure below, $\overline{AC} \cong \overline{DF}$ and $\angle A \cong \angle D$.

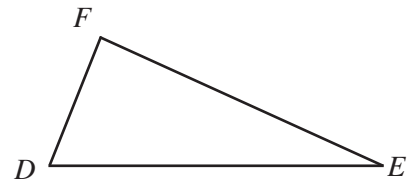
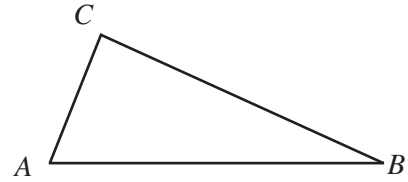

Which additional information would be enough to prove that $\triangle ABC \cong \triangle DEF$?

- A $\overline{AB} \cong \overline{DE}$
 B $\overline{AB} \cong \overline{BC}$
 C $\overline{BC} \cong \overline{EF}$
 D $\overline{BC} \cong \overline{DE}$

CSG00517

Geometry

Released Test Questions

- 22 Given: \overline{AB} and \overline{CD} intersect at point E ;
 $\angle 1 \cong \angle 2$

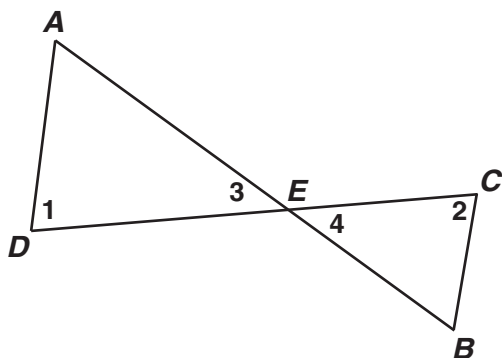

Which theorem or postulate can be used to prove $\triangle AED \sim \triangle BEC$?

- A AA
- B SSS
- C ASA
- D SAS

CSG10074

- 23 Given: E is the midpoint of \overline{CD} ; $\angle C \cong \angle D$

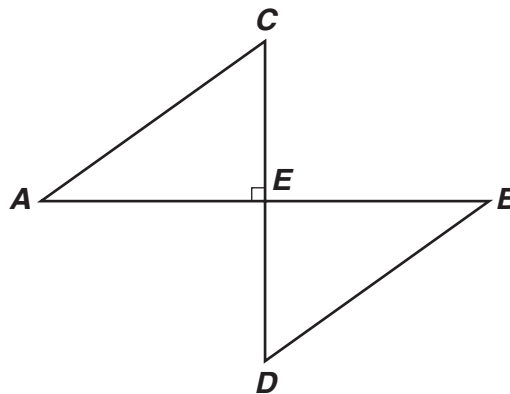

Which of the following statements *must* be true?

- A $\angle A \cong \angle D$
- B $\angle B \cong \angle C$
- C $\overline{CE} \cong \overline{BE}$
- D $\overline{AC} \cong \overline{BD}$

CSG10078

- 24 In the figure below, n is a whole number. What is the *smallest* possible value for n ?

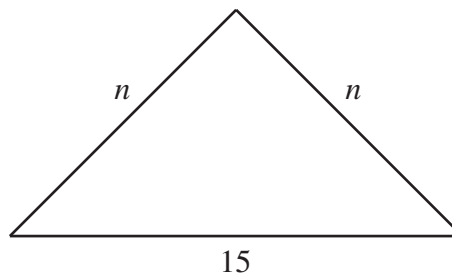

- A 1
- B 7
- C 8
- D 14

CSG00295

Released Test Questions

Geometry

- 25 Which of the following sets of numbers could represent the lengths of the sides of a triangle?

A 2, 2, 5
 B 3, 3, 5
 C 4, 4, 8
 D 5, 5, 15

CSG10041

- 26 In the accompanying diagram, parallel lines l and m are cut by transversal t .

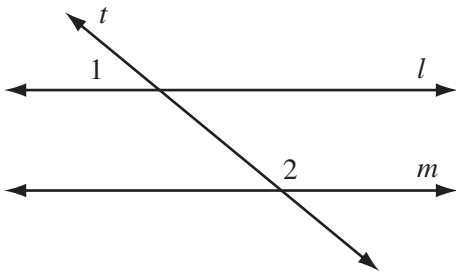

Which statement about angles 1 and 2 *must* be true?

A $\angle 1 \cong \angle 2$.
 B $\angle 1$ is the complement of $\angle 2$.
 C $\angle 1$ is the supplement of $\angle 2$.
 D $\angle 1$ and $\angle 2$ are right angles.

CSG00579

- 27 What values of a and b make quadrilateral $MNOP$ a parallelogram?

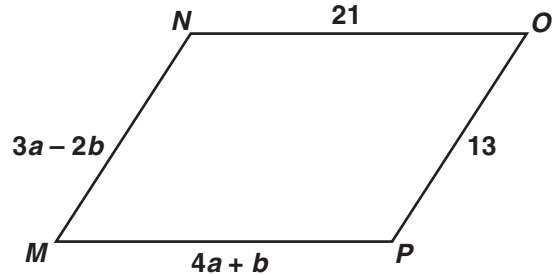

A $a = 1, b = 5$
 B $a = 5, b = 1$
 C $a = \frac{11}{7}, b = \frac{34}{7}$
 D $a = \frac{34}{7}, b = \frac{11}{7}$

CSG10163

- 28 Quadrilateral $ABCD$ is a parallelogram. If adjacent angles are congruent, which statement *must* be true?

A Quadrilateral $ABCD$ is a square.
 B Quadrilateral $ABCD$ is a rhombus.
 C Quadrilateral $ABCD$ is a rectangle.
 D Quadrilateral $ABCD$ is an isosceles trapezoid.

CSG20048

Geometry

Released Test Questions

- 29 For the quadrilateral shown below, what is $m\angle a + m\angle c$?

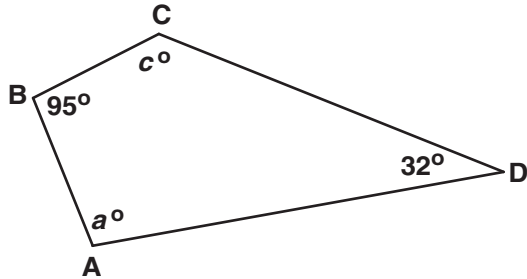

- A 53°
- B 137°
- C 180°
- D 233°

CSG10162

- 30 If $ABCD$ is a parallelogram, what is the length of segment BD ?

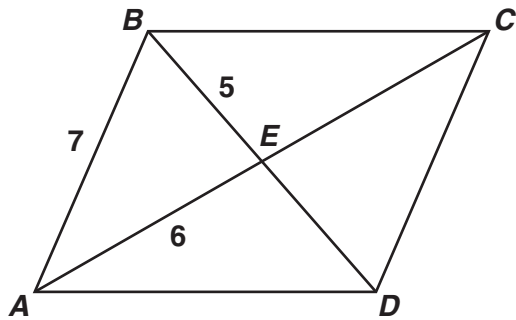

- A 10
- B 11
- C 12
- D 14

CSG20236

- 31 The diameter of a circle is 12 meters. If point P is in the same plane as the circle, and is 6 meters from the center of the circle, which *best* describes the location of point P ?

- A Point P must be on the circle.
- B Point P must be inside the circle.
- C Point P may be either outside the circle or on the circle.
- D Point P may be either inside the circle or on the circle.

CSG00532

- 32 Given: $p \parallel q$;
 $m \parallel n$;
 $m\angle 1 = 75^\circ$

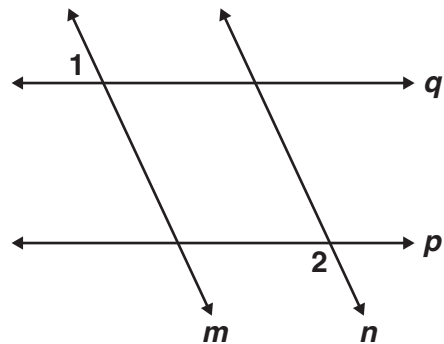

What is $m\angle 2$?

- A 15°
- B 75°
- C 90°
- D 105°

CSG20041

Released Test Questions

Geometry

- 33** A right circular cone has radius 5 inches and height 8 inches.

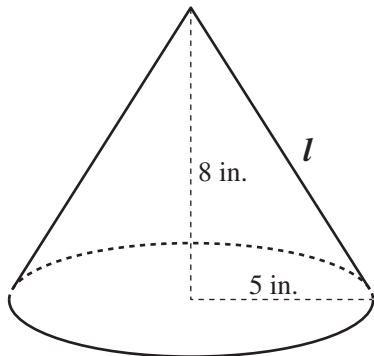

What is the lateral area of the cone? (Lateral area of cone = πrl , where l = slant height)

- A 40π sq in.
- B 445π sq in.
- C $5\pi\sqrt{39}$ sq in.
- D $5\pi\sqrt{89}$ sq in.

CSG00053

- 34** Figure $ABCD$ is a kite.

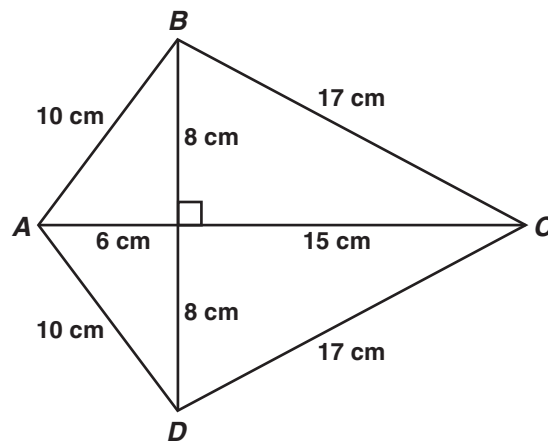

What is the area of figure $ABCD$, in square centimeters?

- A 120
- B 154
- C 168
- D 336

CSG20157

- 35** If a cylindrical barrel measures 22 inches in diameter, how many inches will it roll in 8 revolutions along a smooth surface?

- A 121π in.
- B 168π in.
- C 176π in.
- D 228π in.

CSG00564

Geometry

Released Test Questions

- 36** A sewing club is making a quilt consisting of 25 squares with each side of the square measuring 30 centimeters. If the quilt has five rows and five columns, what is the perimeter of the quilt?

- A 150 cm
- B 300 cm
- C 600 cm
- D 900 cm

CSG20111

- 37** The minute hand of a clock is 5 inches long. What is the area of the circle, in square inches, created as the hand sweeps an hour?

- A 10π
- B 20π
- C 25π
- D 100π

CSG10223

- 38** The four sides of this figure will be folded up and taped to make an open box.

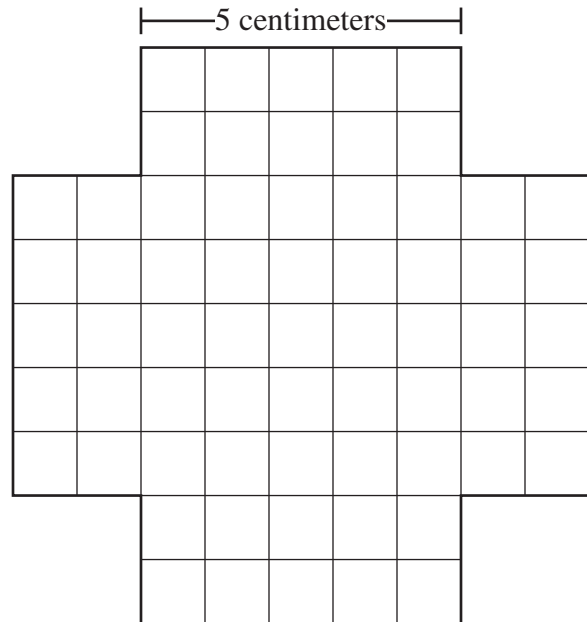

What will be the volume of the box?

- A 50 cm^3
- B 75 cm^3
- C 100 cm^3
- D 125 cm^3

CSG00299

Released Test Questions

Geometry

- 39 A classroom globe has a diameter of 18 inches.



Which of the following is the approximate surface area, in square inches, of the globe?
(Surface Area = $4\pi r^2$)

- A 113.0
- B 226.1
- C 254.3
- D 1017.4

CSG20238

- 40 Vik is constructing a spherical model of Earth for his science fair project. His model has a radius of 24 inches. Since roughly 75% of Earth's surface is covered by water, he wanted to paint 75% of his model blue to illustrate this fact. Approximately how many square inches on his model will be painted blue?
(Surface Area = $4\pi r^2$)

- A 5426
- B 7235
- C 43,407
- D 57,877

CSG10086

- 41 The rectangle shown below has length 20 meters and width 10 meters.

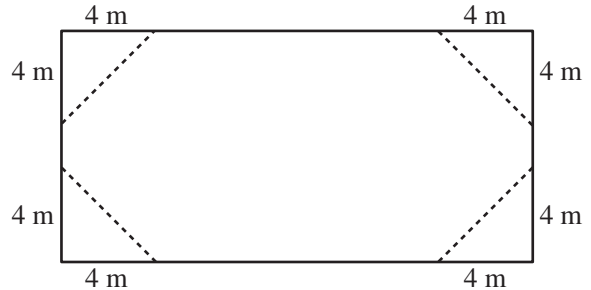

If four triangles are removed from the rectangle as shown, what will be the area of the remaining figure?

- A 136 m^2
- B 144 m^2
- C 168 m^2
- D 184 m^2

CSG00012

- 42 If $RSTW$ is a rhombus, what is the area of $\triangle WXT$?

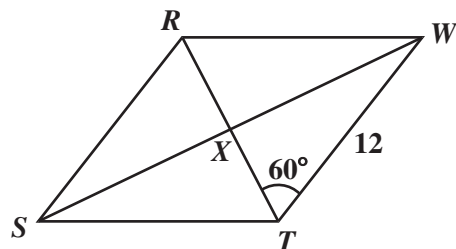

- A $18\sqrt{3}$
- B $36\sqrt{3}$
- C 36
- D 48

CSG00227

Geometry

Released Test Questions

- 43** What is the area, in square units, of the trapezoid shown below?

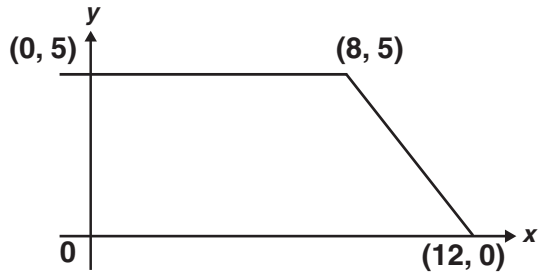

- A 37.5
- B 42.5
- C 50
- D 100

CSG20226

- 44** The figure below is a square with four congruent parallelograms inside.

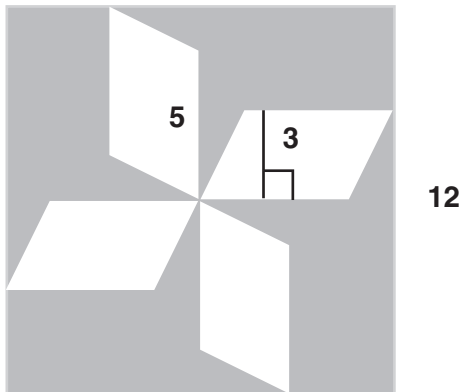

What is the area, in square units, of the shaded portion?

- A 60
- B 84
- C 114
- D 129

CSG20225

- 45** What is the area, in square meters (m), of the trapezoid shown below?

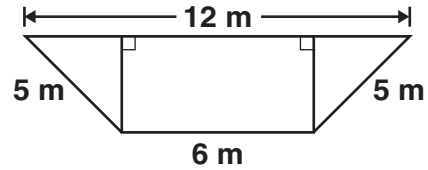

- A 28
- B 36
- C 48
- D 72

CSG10047

- 46** What is the area, in square inches (in.), of the triangle below?

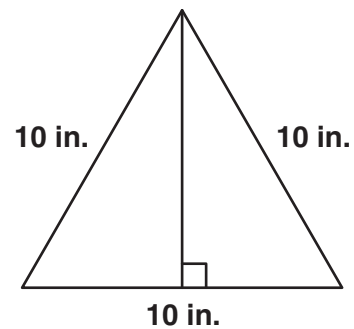

- A 25
- B $25\sqrt{3}$
- C 50
- D $50\sqrt{3}$

CSG10048

Released Test Questions

Geometry

- 47 What is the area, in square centimeters, of rhombus $RSTV$ if $RT = 16$ cm and $SV = 12$ cm?

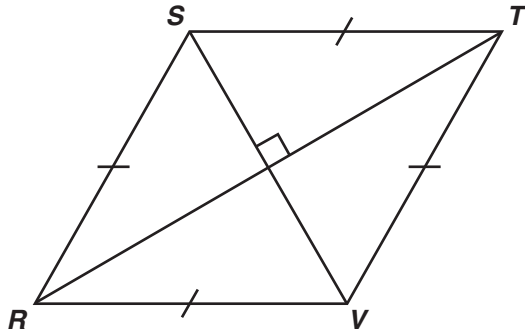

- A 40
B 48
C 96
D 192

CSG20144

- 48 The perimeters of two squares are in a ratio of 4 to 9. What is the ratio between the areas of the two squares?

- A 2 to 3
B 4 to 9
C 16 to 27
D 16 to 81

CSG00013

- 49 Lea made two candles in the shape of right rectangular prisms. The first candle is 15 cm high, 8 cm long, and 8 cm wide. The second candle is 5 cm higher but has the same length and width. How much additional wax was needed to make the taller candle?

- A 320 cm^3
B 640 cm^3
C 960 cm^3
D 1280 cm^3

CSG20116

- 50 Two angles of a triangle have measures of 55° and 65° . Which of the following could *not* be a measure of an exterior angle of the triangle?

- A 115°
B 120°
C 125°
D 130°

CSG00571

- 51 The sum of the interior angles of a polygon is the same as the sum of its exterior angles. What type of polygon is it?

- A quadrilateral
B hexagon
C octagon
D decagon

CSG00305

Geometry

Released Test Questions

- 52 What is $m\angle x$?

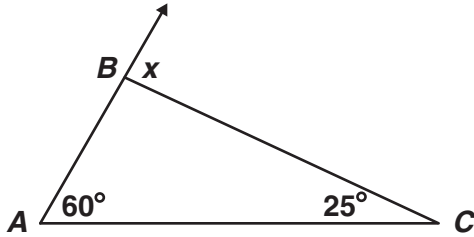

- A 35°
 B 60°
 C 85°
 D 95°

CSG20086

- 53 If the measure of an exterior angle of a regular polygon is 120° , how many sides does the polygon have?

- A 3
 B 4
 C 5
 D 6

CSG20204

- 54 In the figure below, $\overline{AB} \parallel \overline{CD}$.

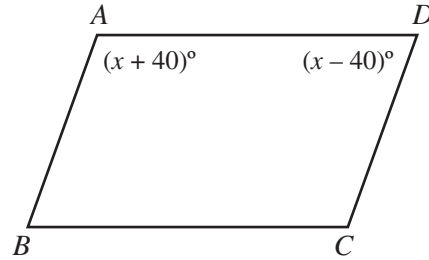

What is the value of x ?

- A 40
 B 50
 C 80
 D 90

CSG00244

- 55 The measures of the interior angles of a pentagon are $2x$, $6x$, $4x - 6$, $2x - 16$, and $6x + 2$. What is the measure, in degrees, of the largest angle?

- A 28
 B 106
 C 170
 D 174

CSG10028

56 A regular polygon has 12 sides. What is the measure of each exterior angle?

- A 15°
- B 30°
- C 45°
- D 60°

CSG00039

57 What is $m\angle 1$?

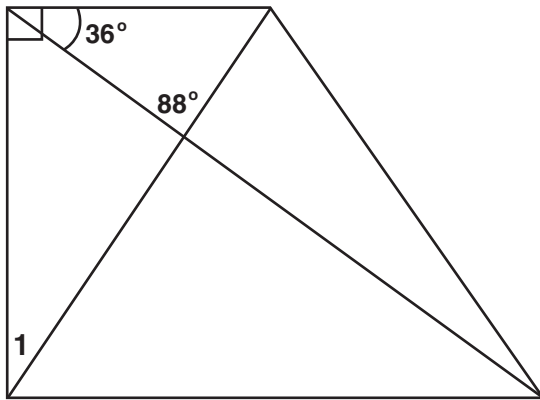

- A 34°
- B 56°
- C 64°
- D 92°

CSG20179

58 What is $m\angle WZX$?

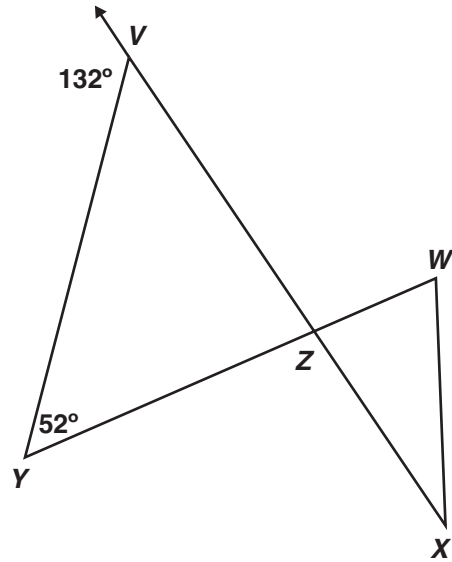

- A 80°
- B 90°
- C 100°
- D 110°

CSG30022

59 What is the measure of an exterior angle of a regular hexagon?

- A 30°
- B 60°
- C 120°
- D 180°

CSG00570

Geometry

Released Test Questions

- 60 A diagram from a proof of the Pythagorean theorem is pictured below.

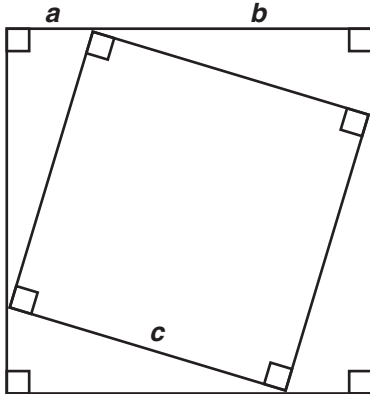

Which statement would *not* be used in the proof of the Pythagorean theorem?

- A The area of a triangle equals $\frac{1}{2}ab$.
- B The four right triangles are congruent.
- C The area of the inner square is equal to half of the area of the larger square.
- D The area of the larger square is equal to the sum of the areas of the smaller square and the four congruent triangles.

CSG10192

- 61 A right triangle's hypotenuse has length 5. If one leg has length 2, what is the length of the other leg?

- A 3
- B $\sqrt{21}$
- C $\sqrt{29}$
- D 7

CSG00566

- 62 A new pipeline is being constructed to re-route its oil flow around the exterior of a national wildlife preserve. The plan showing the old pipeline and the new route is shown below.

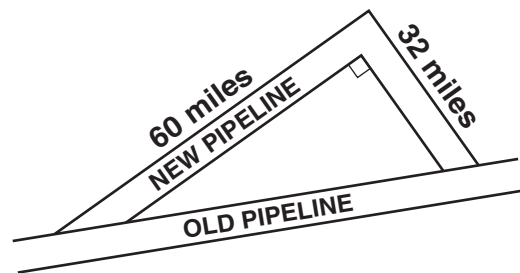

About how many extra miles will the oil flow once the new route is established?

- A 24
- B 68
- C 92
- D 160

CSG10016

Released Test Questions

Geometry

63 What is the height of this rectangle?

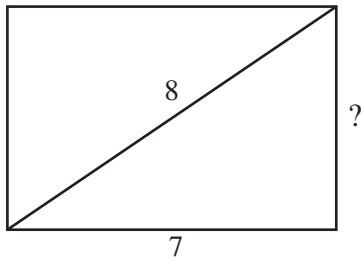

- A 1 unit
- B 6 units
- C $\sqrt{15}$ units
- D $\sqrt{113}$ units

CSG00473

64 Marsha is using a straightedge and compass to do the construction shown below.

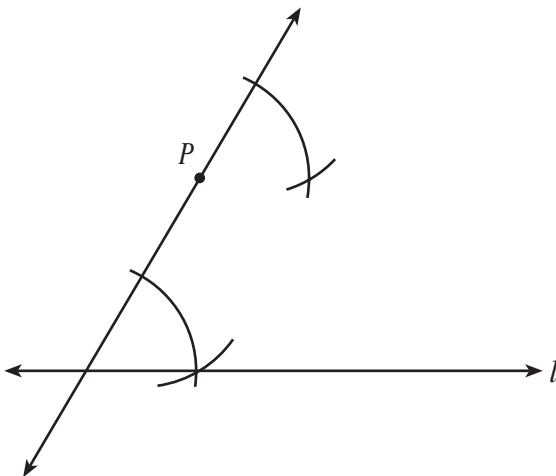

Which *best* describes the construction Marsha is doing?

- A a line through P parallel to line l
- B a line through P intersecting line l
- C a line through P congruent to line l
- D a line through P perpendicular to line l

CSG00526

65 Given: angle A

What is the first step in constructing the angle bisector of angle A ?

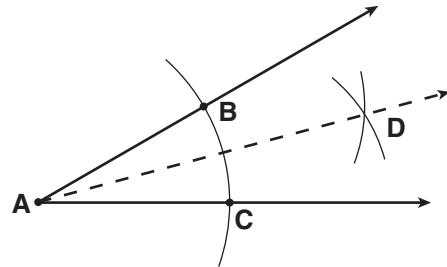

- A Draw ray \overline{AD} .
- B Draw a line segment connecting points B and C .
- C From points B and C , draw equal arcs that intersect at D .
- D From point A , draw an arc that intersects the sides of the angle at points B and C .

CSG10131

66 Scott is constructing a line perpendicular to line l from point P . Which of the following should be his first step?

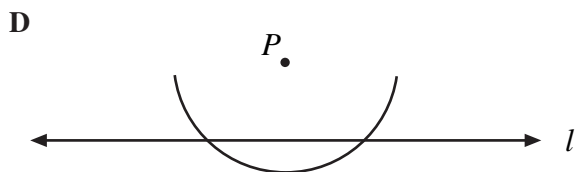
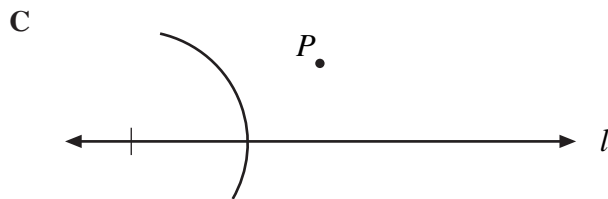
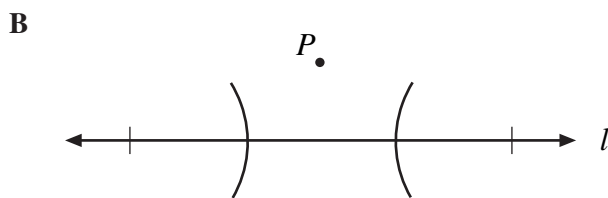
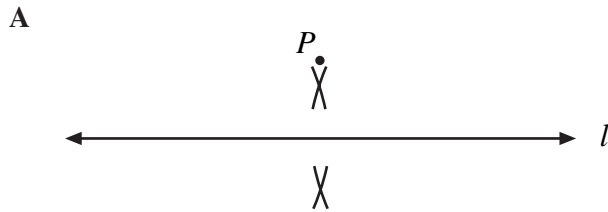

CSG00308

67 Which triangle can be constructed using the following steps?

1. Put the tip of the compass on point A .
2. Open the compass so that the pencil tip is on point B .
3. Draw an arc above \overline{AB} .
4. Without changing the opening, put the metal tip on point B and draw an arc intersecting the first arc at point C .
5. Draw \overline{AC} and \overline{BC} .

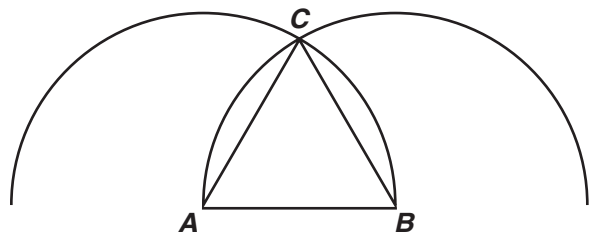

- A right
- B obtuse
- C scalene
- D equilateral

CSG10135

Released Test Questions

Geometry

- 68 What geometric construction is shown in the diagram below?

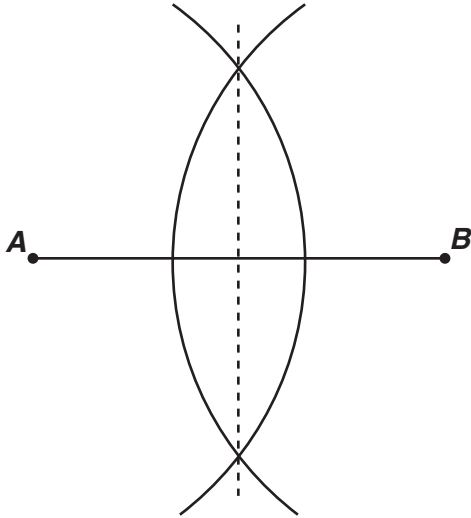

- A an angle bisector
- B a line parallel to a given line
- C an angle congruent to a given angle
- D a perpendicular bisector of a segment

CSG20029

- 69 The diagram shows $\triangle ABC$.

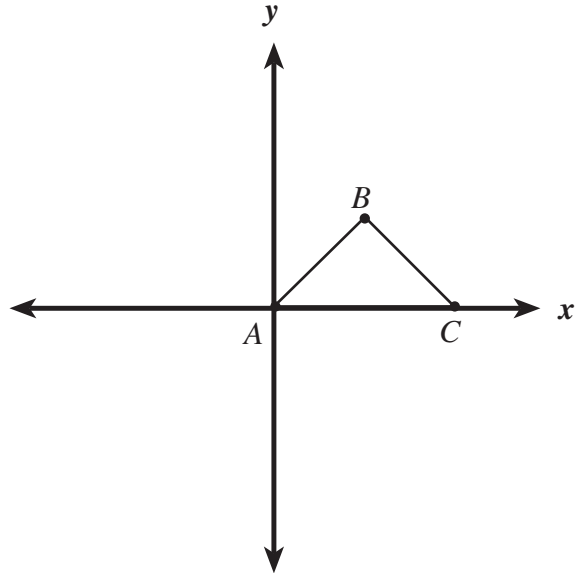

Which statement would prove that $\triangle ABC$ is a right triangle?

- A $(\text{slope } \overline{AB})(\text{slope } \overline{BC}) = 1$
- B $(\text{slope } \overline{AB})(\text{slope } \overline{BC}) = -1$
- C distance from A to B = distance from B to C
- D distance from A to B = $-$ (distance from B to C)

CSG00475

Geometry

Released Test Questions

- 70** Figure $ABCO$ is a parallelogram.

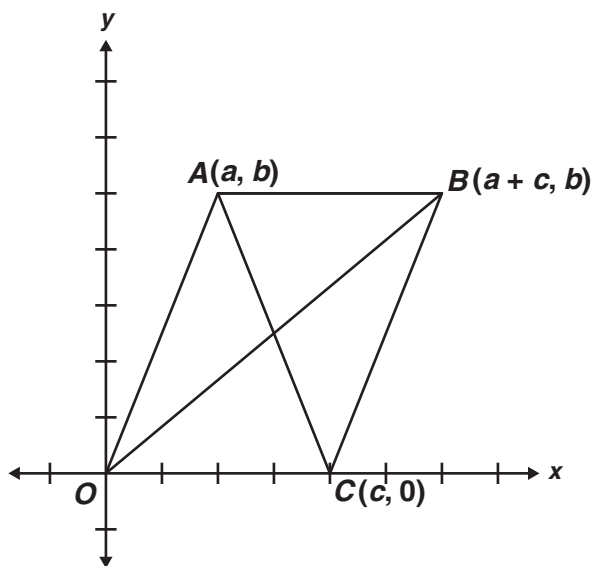

What are the coordinates of the point of intersection of the diagonals?

- A $\left(\frac{a}{2}, \frac{b}{2}\right)$
 B $\left(\frac{c}{2}, \frac{b}{2}\right)$
 C $\left(\frac{a+c}{2}, \frac{b}{2}\right)$
 D $\left(\frac{a+c}{2}, \frac{a+b}{2}\right)$

CSG20101

- 71** What type of triangle is formed by the points $A(4, 2)$, $B(6, -1)$, and $C(-1, 3)$?

- A right
 B equilateral
 C isosceles
 D scalene

CSG10235

- 72** The point $(-3, 2)$ lies on a circle whose equation is $(x + 3)^2 + (y + 1)^2 = r^2$. Which of the following must be the radius of the circle?

- A 3
 B $\sqrt{10}$
 C 9
 D 10

CSG30048

Released Test Questions

Geometry

- 73** What is the length of line segment \overline{PQ} shown below?

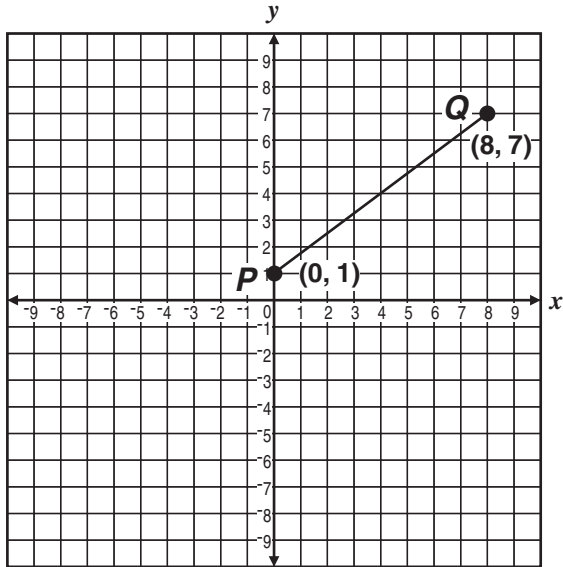

- A 9 units
- B 10 units
- C 13 units
- D 14 units

CSG00540

- 74** In the figure below, if $\sin x = \frac{5}{13}$, what are $\cos x$ and $\tan x$?

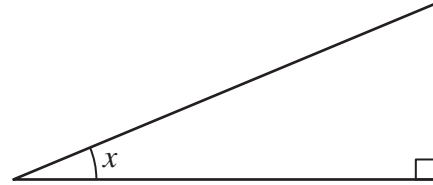

- A $\cos x = \frac{12}{13}$ and $\tan x = \frac{5}{12}$
- B $\cos x = \frac{12}{13}$ and $\tan x = \frac{12}{5}$
- C $\cos x = \frac{13}{12}$ and $\tan x = \frac{5}{12}$
- D $\cos x = \frac{13}{12}$ and $\tan x = \frac{13}{5}$

CSG00493

- 75** In the figure below, $\sin A = 0.7$.

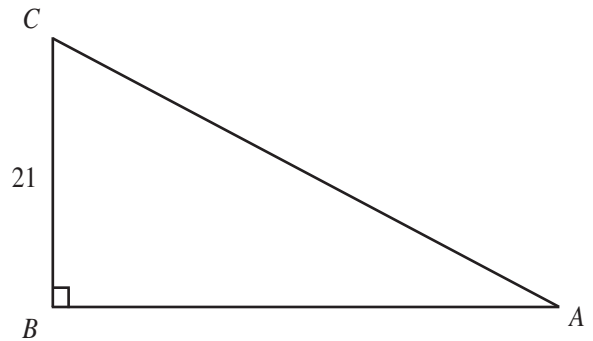

What is the length of \overline{AC} ?

- A 14.7
- B 21.7
- C 30
- D 32

CSG00432

Geometry

Released Test Questions

- 76 Approximately how many feet tall is the streetlight?

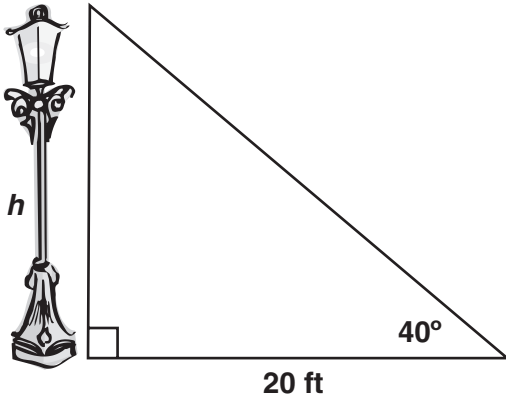

$$\begin{aligned}\sin 40^\circ &\approx 0.64 \\ \cos 40^\circ &\approx 0.77 \\ \tan 40^\circ &\approx 0.84\end{aligned}$$

- A 12.8
B 15.4
C 16.8
D 23.8

CSG20047

- 77 Right triangle ABC is pictured below.

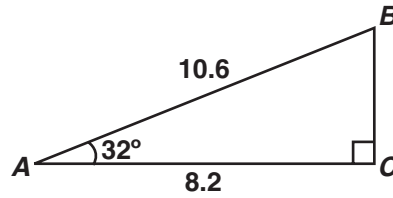

Which equation gives the correct value for BC ?

- A $\sin 32^\circ = \frac{BC}{8.2}$
B $\cos 32^\circ = \frac{BC}{10.6}$
C $\tan 58^\circ = \frac{8.2}{BC}$
D $\sin 58^\circ = \frac{BC}{10.6}$

CSG10210

Released Test Questions

Geometry

- 78** A 13-foot ladder is leaning against a brick wall. The top of the ladder touches the wall 12 feet (ft) above the ground. The bottom of the ladder is 5 ft from the bottom of the wall. What is the sine of the angle formed by the ground and the base of the ladder?

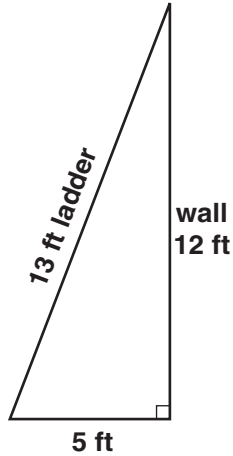

- A $\frac{5}{12}$
 B $\frac{5}{13}$
 C $\frac{12}{13}$
 D $\frac{13}{5}$

CSG10141

- 79** In the accompanying diagram, $m\angle A = 32^\circ$ and $AC = 10$. Which equation could be used to find x in $\triangle ABC$?

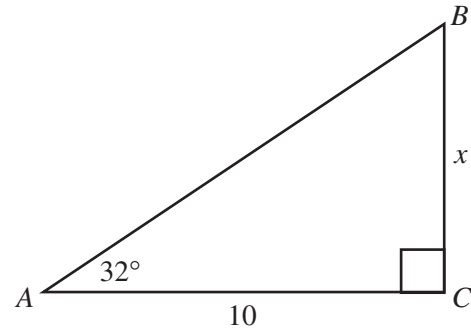

- A $x = 10 \sin 32^\circ$
 B $x = 10 \cos 32^\circ$
 C $x = 10 \tan 32^\circ$
 D $x = \frac{10}{\cos 32^\circ}$

CSG00555

Geometry

Released Test Questions

- 80** The diagram shows an 8-foot ladder leaning against a wall. The ladder makes a 53° angle with the wall. Which is closest to the distance up the wall the ladder reaches?

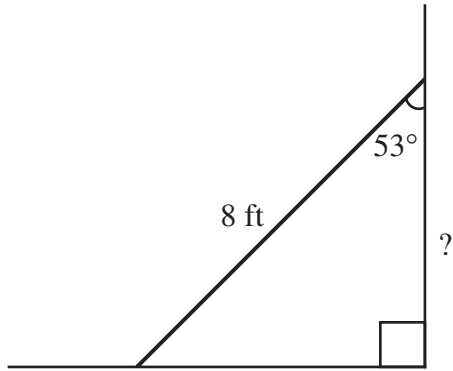

$\sin 53^\circ \approx 0.80$ $\cos 53^\circ \approx 0.60$ $\tan 53^\circ \approx 1.33$
--

- A 3.2 ft
 B 4.8 ft
 C 6.4 ft
 D 9.6 ft

CSG00342

- 81** Triangle JKL is shown below.

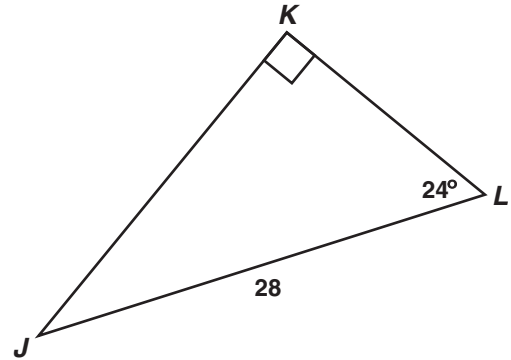

Which equation should be used to find the length of \overline{JK} ?

- A $\sin 24^\circ = \frac{JK}{28}$
 B $\sin 24^\circ = \frac{28}{JK}$
 C $\cos 24^\circ = \frac{JK}{28}$
 D $\cos 24^\circ = \frac{28}{JK}$

CSG20031

Released Test Questions

Geometry

- 82 What is the approximate height, in feet, of the tree in the figure below?

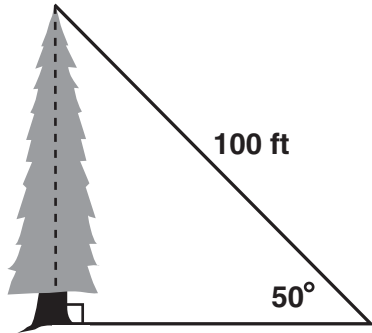

$$\begin{aligned}\sin 50^\circ &\approx 0.766 \\ \cos 50^\circ &\approx 0.643 \\ \tan 50^\circ &\approx 1.192\end{aligned}$$

- A 64.3
B 76.6
C 119.2
D 130.5

- 83 What is the approximate value of x in the triangle below?

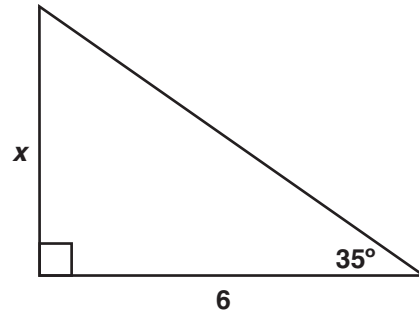

$$\begin{aligned}\sin 35^\circ &\approx 0.57 \\ \cos 35^\circ &\approx 0.82 \\ \tan 35^\circ &\approx 0.7\end{aligned}$$

- A 3.4 units
B 4.2 units
C 4.9 units
D 7.3 units

CSG20126

CSG30029

Geometry

Released Test Questions

- 84 If $a = 3\sqrt{3}$ in the right triangle below, what is the value of b ?

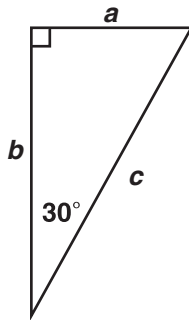

- A 9
 B $6\sqrt{3}$
 C $12\sqrt{3}$
 D 18

CSG10052

- 85 What is the value of x in the triangle below?

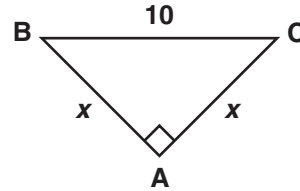

- A 5
 B $5\sqrt{2}$
 C $10\sqrt{3}$
 D 20

CSG10056

Released Test Questions

Geometry

- 86 What is the value of x , in inches?

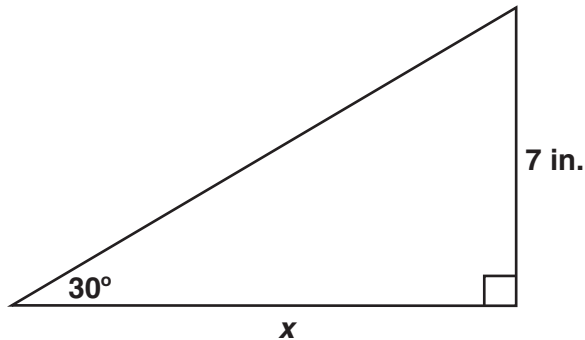

- A $7\sqrt{3}$
 B 14
 C $14\sqrt{3}$
 D 21

CSG20099

- 87 A square is circumscribed about a circle. What is the ratio of the area of the circle to the area of the square?

- A $\frac{1}{4}$
 B $\frac{1}{2}$
 C $\frac{2}{\pi}$
 D $\frac{\pi}{4}$

CSG00585

- 88 In the circle below, \overline{AB} and \overline{CD} are chords intersecting at E .

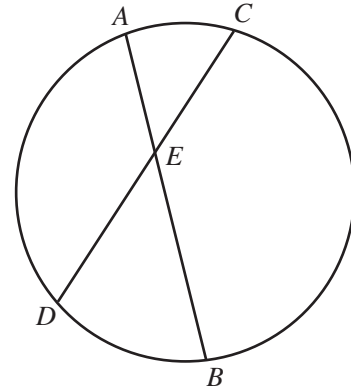

If $AE = 5$, $BE = 12$, and $CE = 6$, what is the length of \overline{DE} ?

- A 7
 B 9
 C 10
 D 13

CSG00022

Geometry

Released Test Questions

- 89 \overline{RB} is tangent to a circle, whose center is A , at point B . \overline{BD} is a diameter.

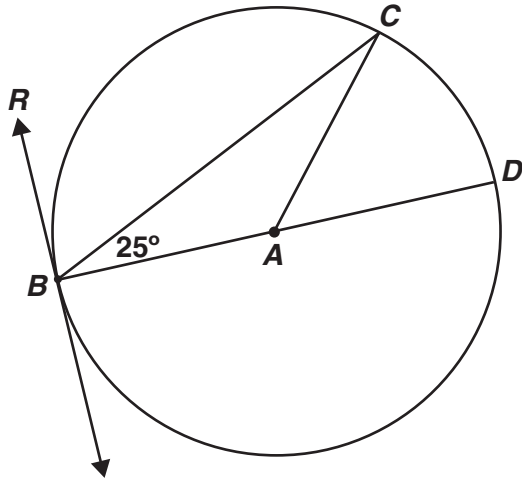

What is $m\angle CBR$?

- A 50°
- B 65°
- C 90°
- D 130°

CSG20186

- 90 In the figure below, \overline{AB} is tangent to circle O at point A , secant \overline{BD} intersects circle O at points C and D , $m\widehat{AC} = 70^\circ$, and $m\widehat{CD} = 110^\circ$.

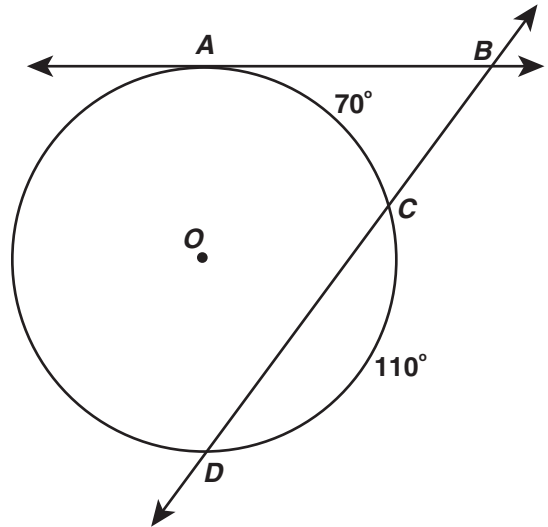

What is $m\angle ABC$?

- A 20°
- B 40°
- C 55°
- D 70°

CSG10257

Released Test Questions

Geometry

- 91 In the circle shown below, the measure of $\widehat{PR} = 140^\circ$ and the measure of $\angle RPQ = 50^\circ$.

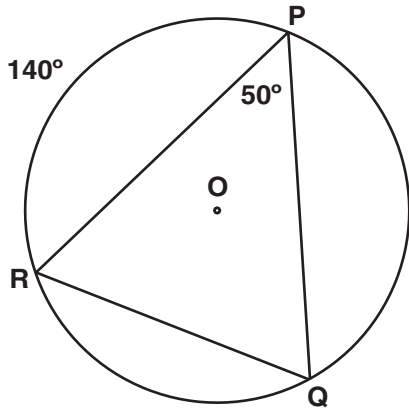

What is the measure of \widehat{PQ} ?

- A 50°
- B 60°
- C 70°
- D 120°

CSG10003

- 92 \overline{QS} is a diameter of the circle below, and $\overline{QS} \perp \overline{PR}$.

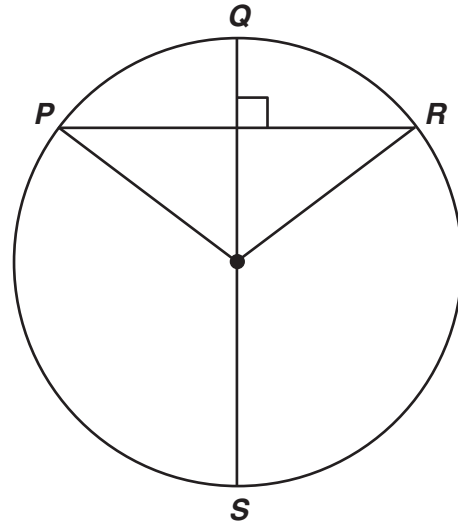

If $m\widehat{PQR} = 106^\circ$, what is $m\widehat{PS}$?

- A 53°
- B 74°
- C 106°
- D 127°

CSG20187

- 93 The vertices of $\triangle ABC$ are $A(2, 1)$, $B(3, 4)$, and $C(1, 3)$. If $\triangle ABC$ is translated 1 unit down and 3 units to the left to create $\triangle DEF$, what are the coordinates of the vertices of $\triangle DEF$?

- A $D(0, 1)$, $E(1, 2)$, $F(1, 3)$
- B $D(0, -1)$, $E(0, 3)$, $F(-2, -2)$
- C $D(-2, 2)$, $E(0, 3)$, $F(-1, 0)$
- D $D(-1, 0)$, $E(0, 3)$, $F(-2, 2)$

CSG00317

Geometry

Released Test Questions

- 94** If triangle ABC is rotated 180 degrees about the origin, what are the coordinates of A' ?

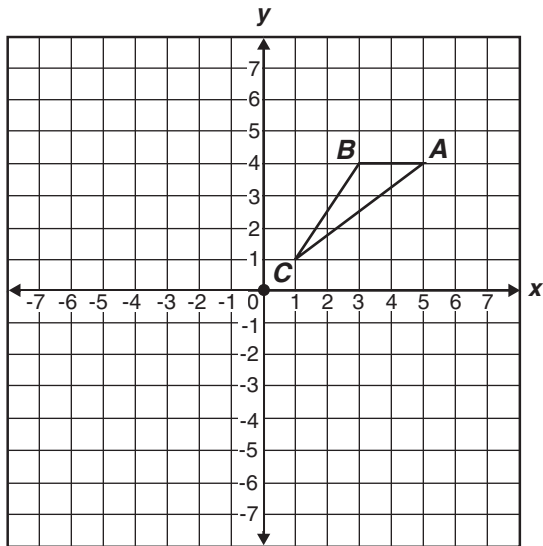

- A $(-5, -4)$
- B $(-5, 4)$
- C $(-4, 5)$
- D $(-4, -5)$

CSG10096

- 95** Trapezoid $ABCD$ below is to be translated to trapezoid $A'B'C'D'$ by the following motion rule.

$$(x, y) \rightarrow (x + 3, y - 4)$$

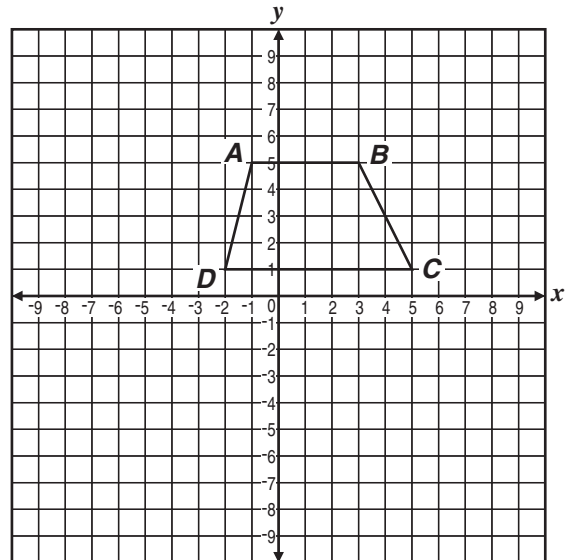

What will be the coordinates of vertex C' ?

- A $(1, -3)$
- B $(2, 1)$
- C $(6, 1)$
- D $(8, -3)$

CSG10214

96 Which expression describes the translation of a point from $(-3, 4)$ to $(4, -1)$?

- A 7 units left and 5 units up
- B 7 units right and 5 units up
- C 7 units left and 5 units down
- D 7 units right and 5 units down

CSG20057

Question Number	Correct Answer	Standard	Year of Release
1	A	GE1.0	2004
2	A	GE1.0	2005
3	C	GE1.0	2007
4	D	GE2.0	2003
5	D	GE2.0	2004
6	D	GE2.0	2005
7	B	GE2.0	2007
8	B	GE3.0	2003
9	D	GE3.0	2004
10	C	GE3.0	2005
11	A	GE3.0	2006
12	D	GE3.0	2008
13	D	GE4.0	2003
14	C	GE4.0	2004
15	C	GE4.0	2005
16	B	GE4.0	2005
17	D	GE4.0	2006
18	A	GE4.0	2007
19	D	GE4.0	2007
20	B	GE4.0	2008
21	A	GE5.0	2003
22	A	GE5.0	2004
23	D	GE5.0	2008
24	C	GE6.0	2003
25	B	GE6.0	2007
26	C	GE7.0	2003
27	B	GE7.0	2004
28	C	GE7.0	2005
29	D	GE7.0	2006
30	A	GE7.0	2006
31	A	GE7.0	2008
32	D	GE7.0	2008
33	D	GE8.0	2003
34	C	GE8.0	2005
35	C	GE8.0	2006

Question Number	Correct Answer	Standard	Year of Release
36	<i>C</i>	GE8.0	2007
37	<i>C</i>	GE8.0	2008
38	<i>A</i>	GE9.0	2006
39	<i>D</i>	GE9.0	2006
40	<i>A</i>	GE9.0	2008
41	<i>C</i>	GE10.0	2003
42	<i>A</i>	GE10.0	2004
43	<i>C</i>	GE10.0	2005
44	<i>B</i>	GE10.0	2006
45	<i>B</i>	GE10.0	2007
46	<i>B</i>	GE10.0	2007
47	<i>C</i>	GE10.0	2008
48	<i>D</i>	GE11.0	2004
49	<i>A</i>	GE11.0	2005
50	<i>D</i>	GE12.0	2003
51	<i>A</i>	GE12.0	2003
52	<i>C</i>	GE12.0	2005
53	<i>A</i>	GE12.0	2005
54	<i>D</i>	GE12.0	2006
55	<i>C</i>	GE12.0	2007
56	<i>B</i>	GE12.0	2008
57	<i>A</i>	GE13.0	2005
58	<i>A</i>	GE13.0	2006
59	<i>B</i>	GE13.0	2007
60	<i>C</i>	GE14.0	2004
61	<i>B</i>	GE15.0	2003
62	<i>A</i>	GE15.0	2004
63	<i>C</i>	GE15.0	2008
64	<i>A</i>	GE16.0	2003
65	<i>D</i>	GE16.0	2004
66	<i>D</i>	GE16.0	2006
67	<i>D</i>	GE16.0	2007
68	<i>D</i>	GE16.0	2008
69	<i>B</i>	GE17.0	2004
70	<i>C</i>	GE17.0	2005

Question Number	Correct Answer	Standard	Year of Release
71	<i>D</i>	GE17.0	2006
72	<i>A</i>	GE17.0	2007
73	<i>B</i>	GE17.0	2008
74	<i>A</i>	GE18.0	2003
75	<i>C</i>	GE18.0	2004
76	<i>C</i>	GE18.0	2006
77	<i>C</i>	GE18.0	2007
78	<i>C</i>	GE18.0	2008
79	<i>C</i>	GE19.0	2003
80	<i>B</i>	GE19.0	2005
81	<i>A</i>	GE19.0	2006
82	<i>B</i>	GE19.0	2007
83	<i>B</i>	GE19.0	2008
84	<i>A</i>	GE20.0	2004
85	<i>B</i>	GE20.0	2005
86	<i>A</i>	GE20.0	2007
87	<i>D</i>	GE21.0	2003
88	<i>C</i>	GE21.0	2004
89	<i>B</i>	GE21.0	2005
90	<i>C</i>	GE21.0	2006
91	<i>D</i>	GE21.0	2007
92	<i>D</i>	GE21.0	2008
93	<i>D</i>	GE22.0	2003
94	<i>A</i>	GE22.0	2004
95	<i>D</i>	GE22.0	2006
96	<i>D</i>	GE22.0	2008