

**Use this space for
computations.**

3 If the universal set is {pennies, nickels, dimes, quarters}, what is the complement of the set {nickels}?

- (1) { }
- (2) {pennies, quarters}
- (3) {pennies, dimes, quarters}
- (4) {pennies, nickels, dimes, quarters}

4 Which situation does *not* describe a causal relationship?

- (1) The higher the volume on a radio, the louder the sound will be.
- (2) The faster a student types a research paper, the more pages the paper will have.
- (3) The shorter the distance driven, the less gasoline that will be used.
- (4) The slower the pace of a runner, the longer it will take the runner to finish the race.

5 A cylinder has a diameter of 10 inches and a height of 2.3 inches. What is the volume of this cylinder, to the *nearest tenth of a cubic inch*?

- (1) 72.3
- (2) 83.1
- (3) 180.6
- (4) 722.6

Use this space for
computations.

6 Based on the box-and-whisker plot below, which statement is *false*?

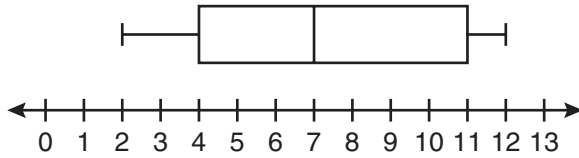

- (1) The median is 7.
 - (2) The range is 12.
 - (3) The first quartile is 4.
 - (4) The third quartile is 11.
- 7 The ninth grade class at a local high school needs to purchase a park permit for \$250.00 for their upcoming class picnic. Each ninth grader attending the picnic pays \$0.75. Each guest pays \$1.25. If 200 ninth graders attend the picnic, which inequality can be used to determine the number of guests, x , needed to cover the cost of the permit?
- (1) $0.75x - (1.25)(200) \geq 250.00$
 - (2) $0.75x + (1.25)(200) \geq 250.00$
 - (3) $(0.75)(200) - 1.25x \geq 250.00$
 - (4) $(0.75)(200) + 1.25x \geq 250.00$
- 8 Which equation represents the line that passes through the point $(1,5)$ and has a slope of -2 ?
- (1) $y = -2x + 7$
 - (2) $y = -2x + 11$
 - (3) $y = 2x - 9$
 - (4) $y = 2x + 3$
- 9 What is the solution of the system of equations $2x - 5y = 11$ and $-2x + 3y = -9$?
- (1) $(-3, -1)$
 - (2) $(-1, 3)$
 - (3) $(3, -1)$
 - (4) $(3, 1)$

Use this space for computations.

10 Which algebraic expression represents 15 less than x divided by 9?

(1) $\frac{x}{9} - 15$

(3) $15 - \frac{x}{9}$

(2) $9x - 15$

(4) $15 - 9x$

11 What are the vertex and the axis of symmetry of the parabola shown in the graph below?

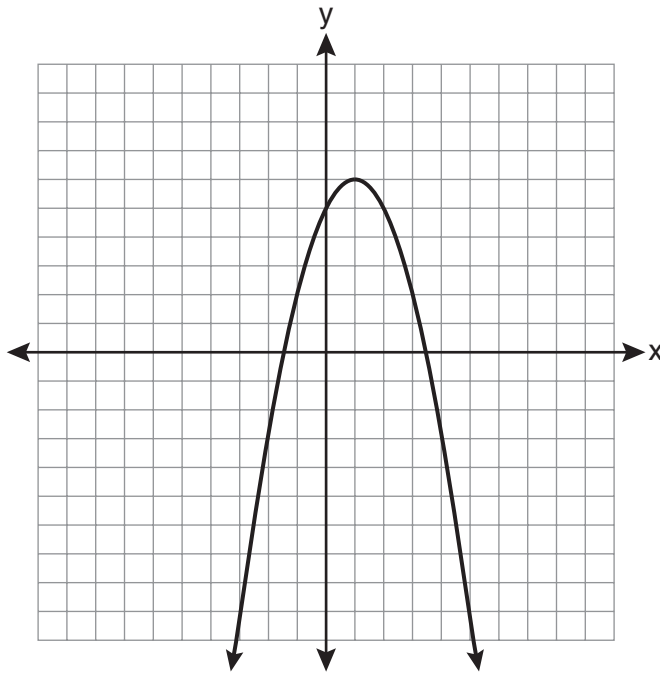

(1) vertex: (1,6); axis of symmetry: $y = 1$

(2) vertex: (1,6); axis of symmetry: $x = 1$

(3) vertex: (6,1); axis of symmetry: $y = 1$

(4) vertex: (6,1); axis of symmetry: $x = 1$

Use this space for computations.

12 The diagram below shows right triangle ABC .

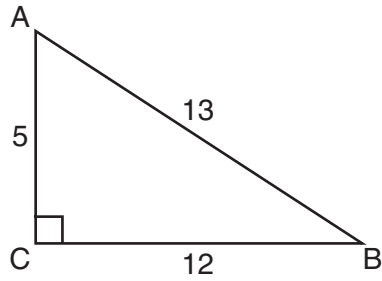

Which ratio represents the tangent of $\angle ABC$?

(1) $\frac{5}{13}$

(3) $\frac{12}{13}$

(2) $\frac{5}{12}$

(4) $\frac{12}{5}$

13 What is the value of the expression $-3x^2y + 4x$ when $x = -4$ and $y = 2$?

(1) -112

(3) 80

(2) -80

(4) 272

14 Which expression is equivalent to $-3x(x - 4) - 2x(x + 3)$?

(1) $-x^2 - 1$

(3) $-5x^2 - 6x$

(2) $-x^2 + 18x$

(4) $-5x^2 + 6x$

**Use this space for
computations.**

19 Ben has four more than twice as many CDs as Jake. If they have a total of 31 CDs, how many CDs does Jake have?

- (1) 9
- (2) 13
- (3) 14
- (4) 22

20 What are the roots of the equation $x^2 - 5x + 6 = 0$?

- (1) 1 and -6
- (2) 2 and 3
- (3) -1 and 6
- (4) -2 and -3

21 What is the solution of the inequality $-6x - 17 \geq 8x + 25$?

- (1) $x \geq 3$
- (2) $x \leq 3$
- (3) $x \geq -3$
- (4) $x \leq -3$

22 Which set of data can be classified as qualitative?

- (1) scores of students in an algebra class
- (2) ages of students in a biology class
- (3) numbers of students in history classes
- (4) eye colors of students in an economics class

**Use this space for
computations.**

23 Jack wants to replace the flooring in his rectangular kitchen. He calculates the area of the floor to be 12.8 square meters. The actual area of the floor is 13.5 square meters. What is the relative error in calculating the area of the floor, to the *nearest thousandth*?

- (1) 0.051 (3) 0.054
(2) 0.052 (4) 0.055

24 The current student population of the Brentwood Student Center is 2,000. The enrollment at the center increases at a rate of 4% each year. To the *nearest whole number*, what will the student population be closest to in 3 years?

- (1) 2,240 (3) 5,488
(2) 2,250 (4) 6,240

25 Maria has a set of 10 index cards labeled with the digits 0 through 9. She puts them in a bag and selects one at random. The outcome that is most likely to occur is selecting

- (1) an odd number
(2) a prime number
(3) a number that is at most 5
(4) a number that is divisible by 3

26 A right triangle contains a 38° angle whose adjacent side measures 10 centimeters. What is the length of the hypotenuse, to the *nearest hundredth of a centimeter*?

- (1) 7.88 (3) 12.80
(2) 12.69 (4) 16.24

Use this space for computations.

27 Which ordered pair is in the solution set of the system of inequalities shown in the graph below?

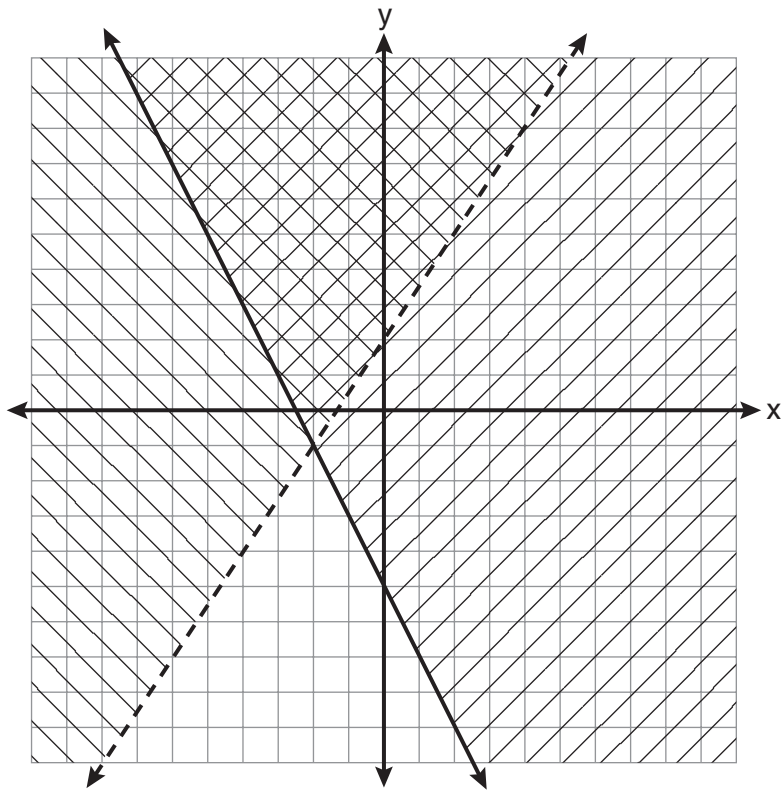

(1) $(-2, -1)$

(3) $(-2, -4)$

(2) $(-2, 2)$

(4) $(2, -2)$

Use this space for computations.

- 28 A garden is in the shape of an isosceles trapezoid and a semicircle, as shown in the diagram below. A fence will be put around the perimeter of the entire garden.

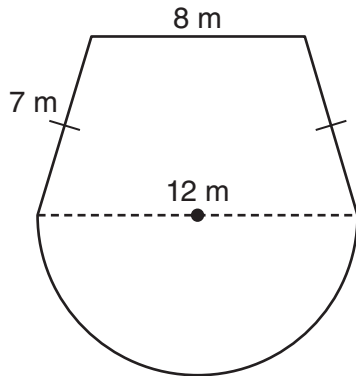

Which expression represents the length of fencing, in meters, that will be needed?

- (1) $22 + 6\pi$ (3) $15 + 6\pi$
(2) $22 + 12\pi$ (4) $15 + 12\pi$
- 29 Which expression represents $36x^2 - 100y^6$ factored completely?
- (1) $2(9x + 25y^3)(9x - 25y^3)$
(2) $4(3x + 5y^3)(3x - 5y^3)$
(3) $(6x + 10y^3)(6x - 10y^3)$
(4) $(18x + 50y^3)(18x - 50y^3)$

- 30 What is the quotient of $\frac{x}{x+4}$ divided by $\frac{2x}{x^2-16}$?

- (1) $\frac{2}{x-4}$ (3) $\frac{2x^2}{x^2-16}$
(2) $\frac{2x^2}{x-4}$ (4) $\frac{x-4}{2}$
-

Part II

Answer all 3 questions in this part. Each correct answer will receive 2 credits. Clearly indicate the necessary steps, including appropriate formula substitutions, diagrams, graphs, charts, etc. For all questions in this part, a correct numerical answer with no work shown will receive only 1 credit. All answers should be written in pen, except for graphs and drawings, which should be done in pencil. [6]

31 Solve for c in terms of a and b : $bc + ac = ab$

32 Ms. Hopkins recorded her students' final exam scores in the frequency table below.

Interval	Tally	Frequency
61-70	###	5
71-80		4
81-90	###	9
91-100	###	6

On the grid below, construct a frequency histogram based on the table.



33 Mrs. Chen owns two pieces of property. The areas of the properties are 77,120 square feet and 33,500 square feet.

$$43,560 \text{ square feet} = 1 \text{ acre}$$

Find the total number of acres Mrs. Chen owns, to the *nearest hundredth of an acre*.

Part III

Answer all 3 questions in this part. Each correct answer will receive 3 credits. Clearly indicate the necessary steps, including appropriate formula substitutions, diagrams, graphs, charts, etc. For all questions in this part, a correct numerical answer with no work shown will receive only 1 credit. All answers should be written in pen, except for graphs and drawings, which should be done in pencil. [9]

- 34 On the set of axes below, graph and label the equations $y = |x|$ and $y = 3|x|$ for the interval $-3 \leq x \leq 3$.

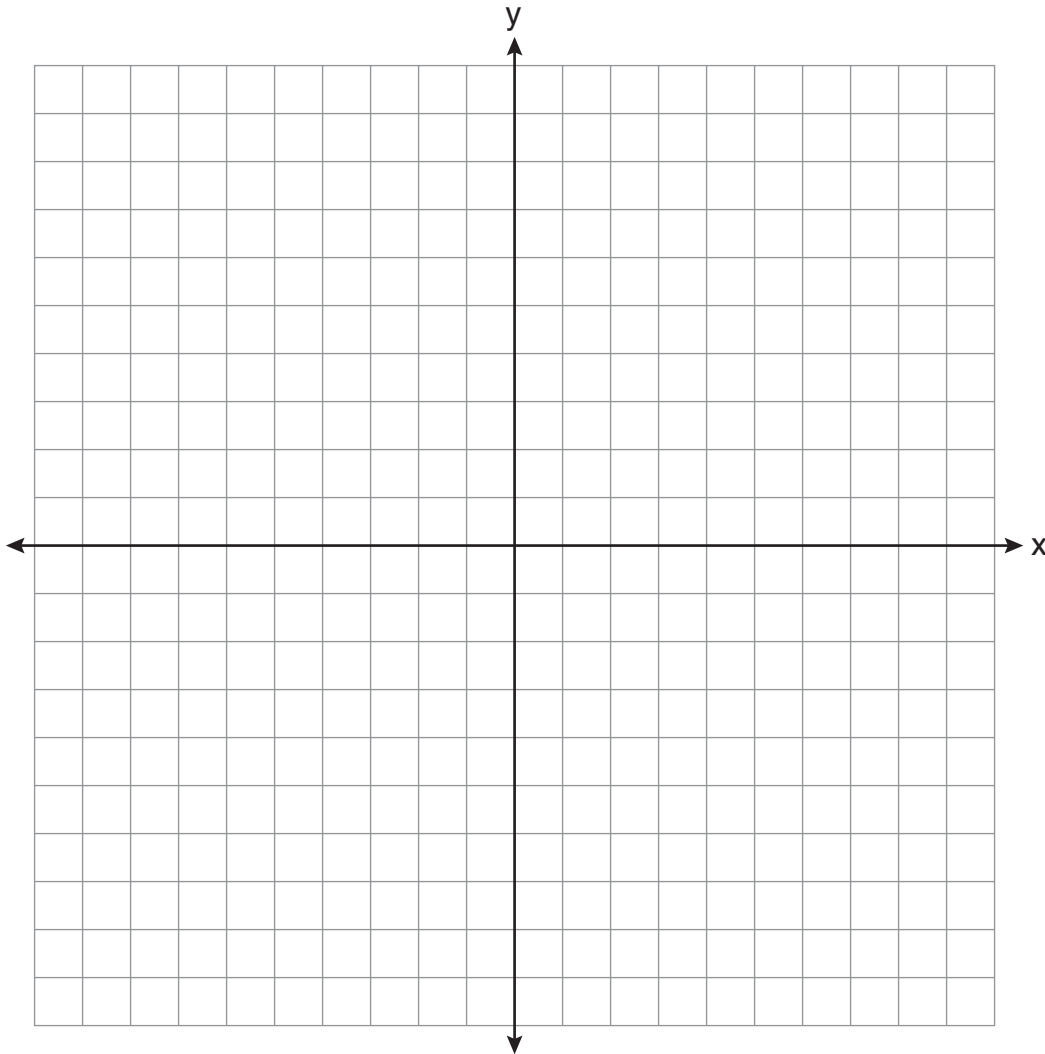

Explain how changing the coefficient of the absolute value from 1 to 3 affects the graph.

35 A trapezoid is shown below.

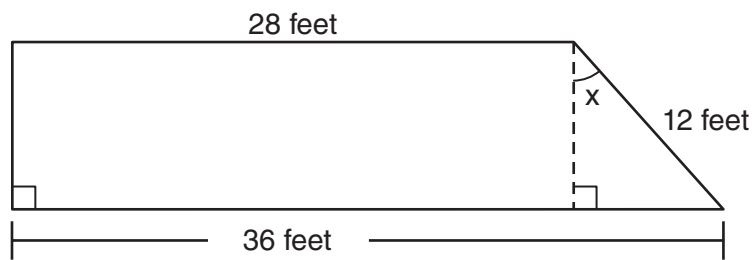

Calculate the measure of angle x , to the *nearest tenth of a degree*.

36 Express $\frac{16\sqrt{21}}{2\sqrt{7}} - 5\sqrt{12}$ in simplest radical form.

Part IV

Answer all 3 questions in this part. Each correct answer will receive 4 credits. Clearly indicate the necessary steps, including appropriate formula substitutions, diagrams, graphs, charts, etc. For all questions in this part, a correct numerical answer with no work shown will receive only 1 credit. All answers should be written in pen, except for graphs and drawings, which should be done in pencil. [12]

37 Vince buys a box of candy that consists of six chocolate pieces, four fruit-flavored pieces, and two mint pieces. He selects three pieces of candy at random, without replacement.

Calculate the probability that the first piece selected will be fruit flavored and the other two will be mint.

Calculate the probability that all three pieces selected will be the same type of candy.

38 On the set of axes below, solve the following system of equations graphically and state the coordinates of *all* points in the solution set.

$$y = -x^2 + 6x - 3$$
$$x + y = 7$$

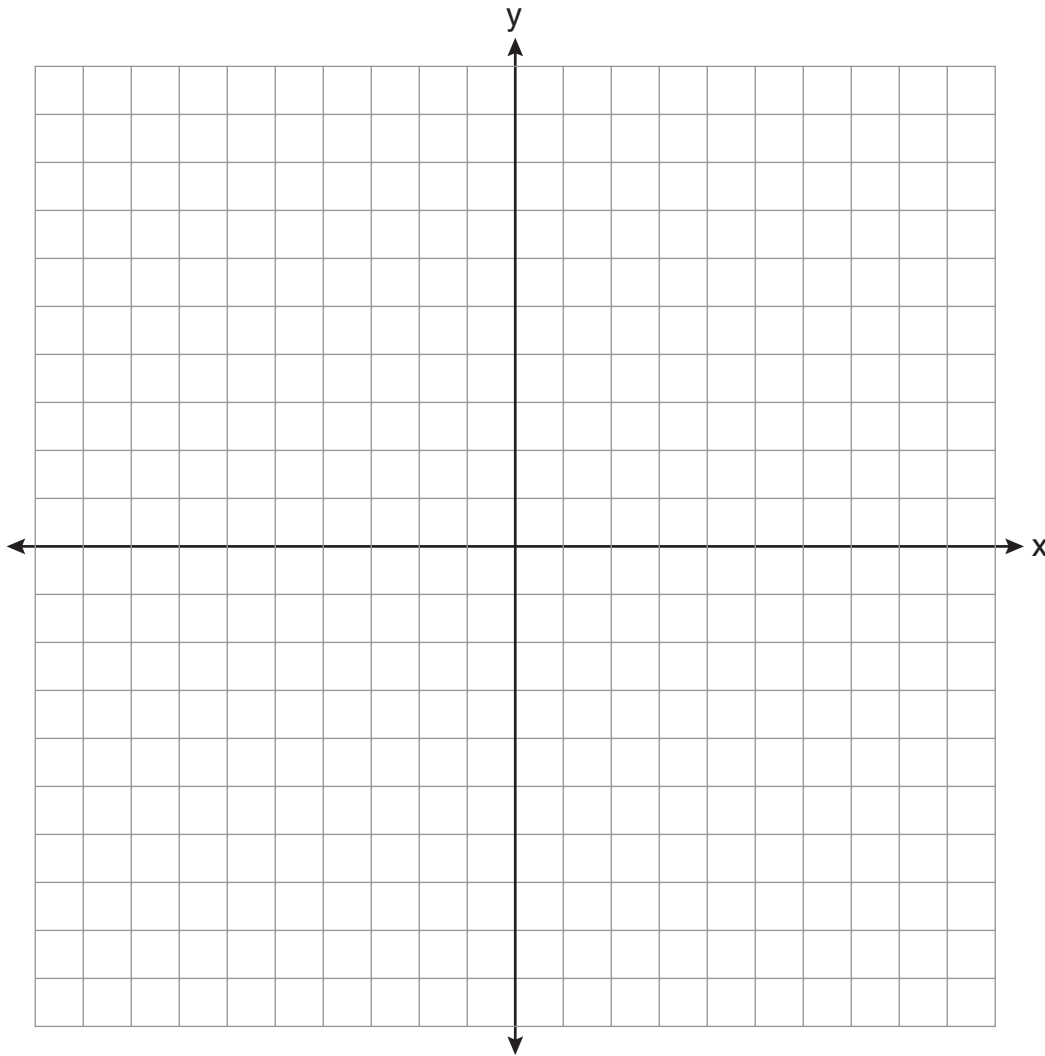

39 Solve for m : $\frac{m}{5} + \frac{3(m-1)}{2} = 2(m-3)$

Part I

Allow a total of 60 credits, 2 credits for each of the following. Allow credit if the student has written the correct answer instead of the numeral 1, 2, 3, or 4.

1 4	11 2	21 4
2 1	12 2	22 4
3 3	13 1	23 2
4 2	14 4	24 2
5 3	15 1	25 3
6 2	16 2	26 2
7 4	17 3	27 2
8 1	18 3	28 1
9 3	19 1	29 2
10 1	20 2	30 4