

Student Name _____

Teacher Name _____

School _____

System _____

ACH



TENNESSEE

LENNESSEE

Tennessee Comprehensive Assessment Program Achievement Test ~ Grade 6 Practice Test



Mathematics

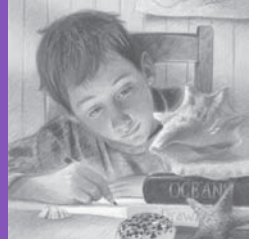

Part 1

1 Roberto is making cookies using a recipe. He will use $\frac{1}{2}$ of every measurement listed in the recipe. If the recipe requires $\frac{3}{4}$ cup of water, how much water should Roberto use?

- A** $\frac{3}{2}$ cups
- B** $\frac{2}{3}$ cup
- C** $\frac{1}{2}$ cup
- D** $\frac{3}{8}$ cup

Go On ►

- 2** The lengths of 4 cars are displayed on the graph.

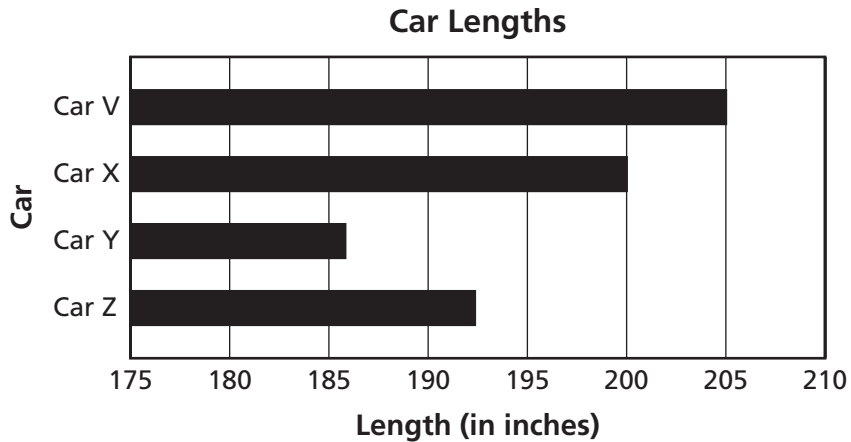

Which feature of the graph may be misleading?

- F** The scale does not start at zero.
- G** The values on the horizontal axis increase by 5.
- H** The bars are horizontal instead of vertical.
- J** The bars are not in order from longest to shortest.

- 3** Fernando's grandparents gave him and his 2 sisters \$42.75 to share equally. What is the total amount of money that Fernando should receive?

- A** \$10.95
- B** \$14.25
- C** \$21.37
- D** \$85.50

- 4** Look at the key below.

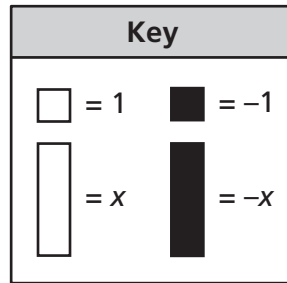

Which expression is represented by this model?



- F** $-2x + 4$
- G** $-4x + 2$
- H** $-4x + (-2)$
- J** $-2x + (-4)$

- 5** Which equation represents the distributive property?

- A** $6 \times (4 + 8) = (6 \times 4) + (6 \times 8)$
- B** $6 + (4 + 8) = (6 + 4) + 8$
- C** $6 + (4 + 8) = (4 + 8) + 6$
- D** $6 \times (4 \times 8) = (6 \times 4) \times 8$

6 The floor area of Ms. Hernandez’s classroom is 900 square feet. A reading center uses 108 square feet of the classroom floor area. What percent of the classroom floor area is used as the reading center?

F 8%

G 12%

H 80%

J 90%

7 Danielle had \$33.58. She spent \$19.99 of this money on art supplies. How much money should Danielle have left?

A \$53.57

B \$26.41

C \$14.58

D \$13.59

8

Which number line shows Point P located closest to 5.5?

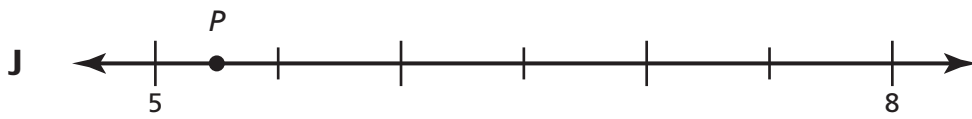
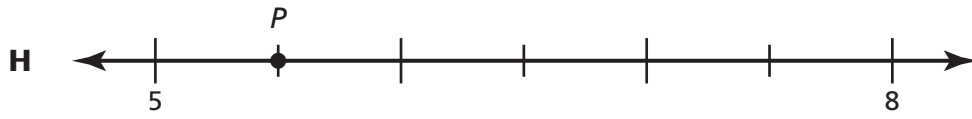
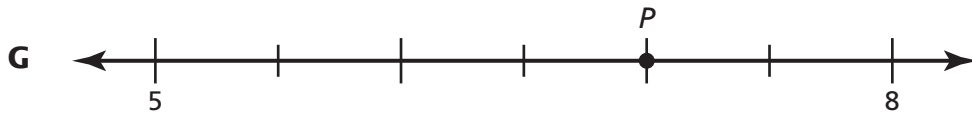
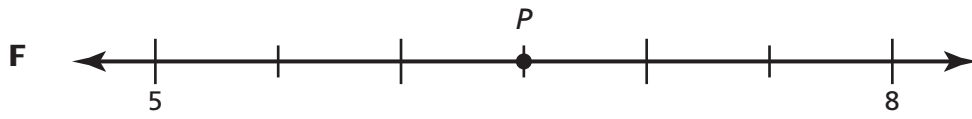

- 9** The results of a morning voting session of 200 students are shown in the table.

Mascot Votes

Animal	Number of Votes
Bulldog	50
Cougar	25
Eagle	10
Mustang	100
Ram	15

Based on the results in the table, how many more votes will be expected for a bulldog mascot if 300 more students vote in the afternoon?

- A** 75
- B** 125
- C** 150
- D** 250

- 10** The table below shows the amount of money Julia earned and spent in a four-day period.

Money Julia Earned and Spent

Day	Activity	Amount
Monday	Earned for washing cars	\$68
Tuesday	Spent on cleaning supplies	\$36
Wednesday	Earned for washing windows	\$75
Thursday	Spent on new clothes	\$28

Which integer best represents the amount of money Julia spent on Tuesday?

- F** -36
- G** -28
- H** 28
- J** 36

- 11** This graph shows the number of different types of pets owned by students in a class.

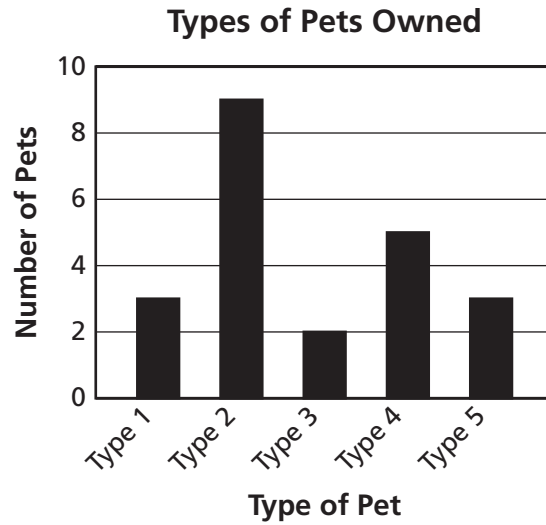

Bianca says that about twice as many dogs as cats are owned by students in this class. What feature of this graph may be misleading?

- A** The vertical scale shows only even numbers.
- B** The bars are not arranged from longest to shortest.
- C** The horizontal axis does not identify the types of pets owned.
- D** The label on the vertical axis does not include the unit used.

- 12** Ahmad set a goal to study for 15 hours this week. On Monday, he studied for $1\frac{1}{2}$ hours. He studied for $2\frac{3}{4}$ hours on Tuesday and $\frac{1}{2}$ hour on Wednesday. How many hours will Ahmad have to study during the rest of the week to meet his goal?

F $4\frac{3}{4}$

G $9\frac{1}{2}$

H $10\frac{1}{4}$

J $11\frac{3}{4}$

- 13** The dimensions of a block of wood shaped like a rectangular prism are shown below.

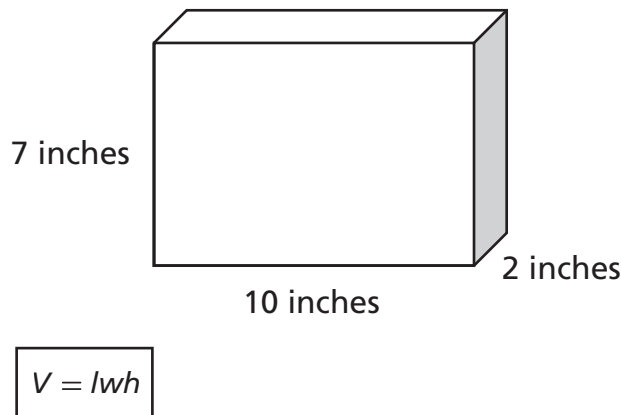

What is the volume of the block of wood?

- A** 208 cubic inches
B 140 cubic inches
C 90 cubic inches
D 70 cubic inches

Go On ►

- 14** The circle below has a diameter of 56 centimeters (cm).

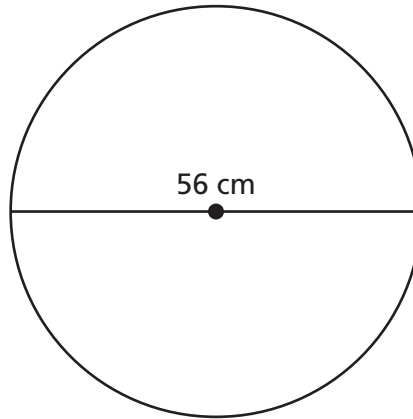

$$A = \pi r^2$$
$$\pi \approx 3.14$$

Which is closest to the area of the circle?

- F** 87.92 cm²
- G** 175.84 cm²
- H** 2,461.76 cm²
- J** 9,847.04 cm²

- 15** Which point is located at $(1, -5)$ on the grid below?

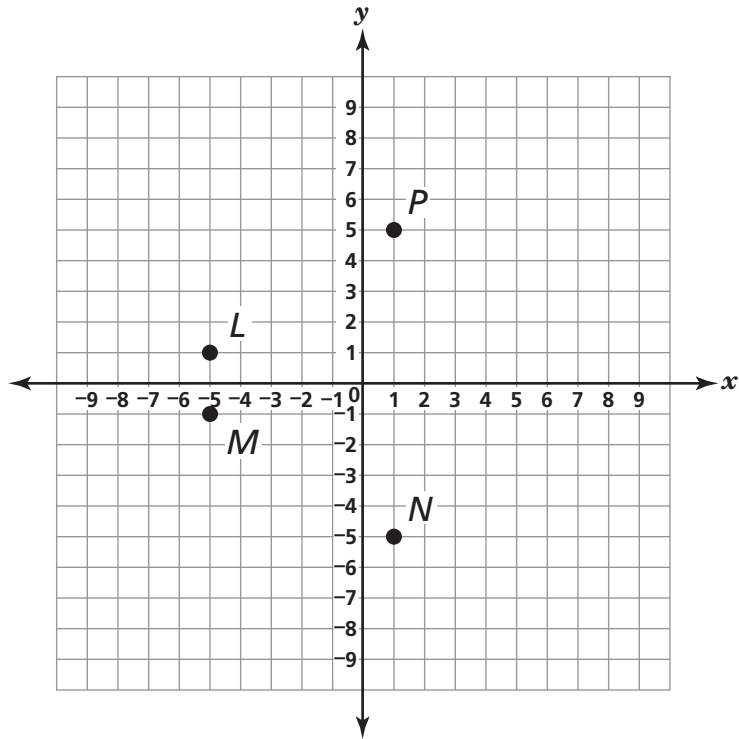

- A** Point L
- B** Point M
- C** Point N
- D** Point P

- 16** A store sold 255 DVDs in 5 days. If sales continue at the same rate, which is the best prediction of the number of DVDs the store could expect to sell in 30 days?

- F** 7,650
- G** 6,000
- H** 1,500
- J** 1,000

17 Solve: $\frac{4}{5} \times \frac{3}{8} =$

A $2\frac{2}{15}$

B $1\frac{7}{40}$

C $\frac{2}{5}$

D $\frac{3}{10}$

18 Trevor ran 97 miles during 5 days of practice for a cross-country race. He ran about the same number of miles each day. Which is the best estimate of the number of miles Trevor ran each day?

F 20

G 25

H 105

J 500

19 Mr. Kincaid has a piece of pipe that is 3.08 meters long. Which length is equivalent to 3.08 meters?

A $3\frac{2}{25}$ meters

B $3\frac{4}{25}$ meters

C $3\frac{1}{5}$ meters

D $3\frac{4}{5}$ meters

20 Which number line shows Point *P* located closest to -15 ?

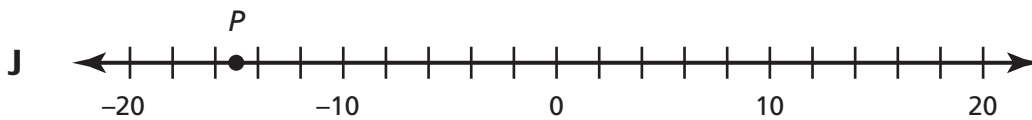
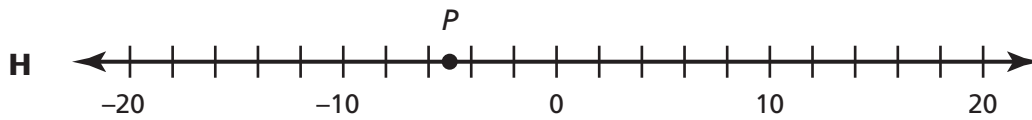
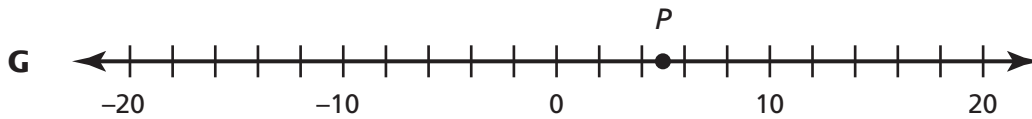
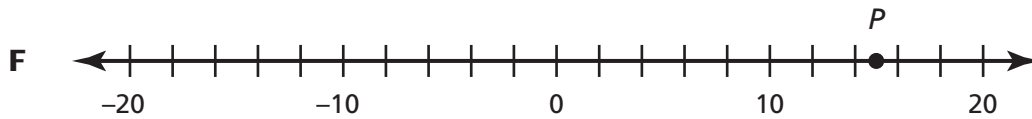

Go On ►

- 21** The table below shows the number of pumpkins sold at a pumpkin patch.

Pumpkins Sold

Size	Number of Pumpkins	Price
Large	100	\$8
Small	y	\$5

A total of \$1,050 was made on the sales of large and small pumpkins. Which equation could be used to find y , the number of small pumpkins that were sold?

- A** $5y + 8(100) = 1,050$
- B** $5y = 8(100) + 1,050$
- C** $5y + 1,050 = 8(100)$
- D** $5y + (8 + 100) = 1,050$

- 22** Which expression is equivalent to $4(m + 8) + 5m$?

- F** $17m$
- G** $41m$
- H** $9m + 8$
- J** $9m + 32$

23 What value of y makes the equation $3y + 9 = 36$ true?

- A** 9
- B** 15
- C** 30
- D** 81

24 Which expression means the same as “9 less than the sum of 10 and 6 times a number n ”?

- F** $9 - (6n \times 10)$
- G** $(6n - 10) - 9$
- H** $9 - (6n + 10)$
- J** $(6n + 10) - 9$

- 25** The circumference of the tire shown below is 72.22 centimeters (cm).

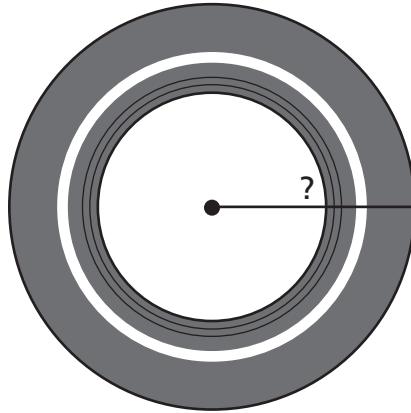

$$\pi \approx 3.14$$

$$C = 2\pi r$$

Which is closest to the radius of the tire?

- A** 4.8 cm
- B** 9.6 cm
- C** 11.5 cm
- D** 23.0 cm

- 26** Raul painted each surface of the cylinder-shaped container shown below.

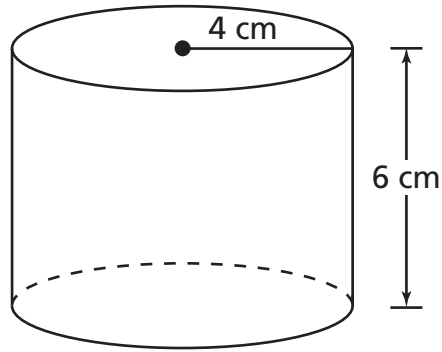

$$SA = 2\pi r^2 + 2\pi rh$$

What is the total surface area that Raul painted, in terms of π ?

- F** $80\pi \text{ cm}^2$
- G** $48\pi \text{ cm}^2$
- H** $40\pi \text{ cm}^2$
- J** $32\pi \text{ cm}^2$

27 Pilar had 6 rows in her garden for planting flowers. She planted daisies in $4\frac{3}{5}$ of the rows.

Which improper fraction is equivalent to $4\frac{3}{5}$?

A $\frac{17}{3}$

B $\frac{17}{5}$

C $\frac{23}{3}$

D $\frac{23}{5}$

28 Look at the figure shown below.

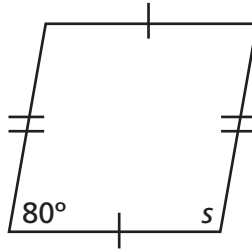

What is the value of s ?

- F** 10°
- G** 20°
- H** 100°
- J** 200°

Part 2

29 Which number line shows Point R located closest to 2.85?

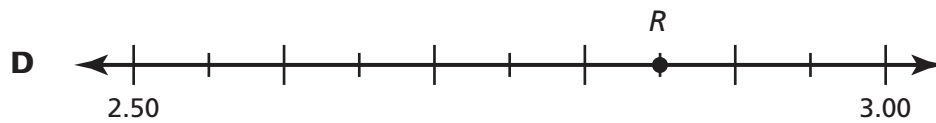
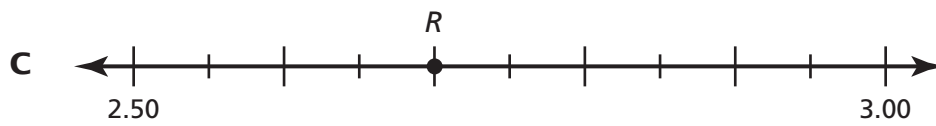
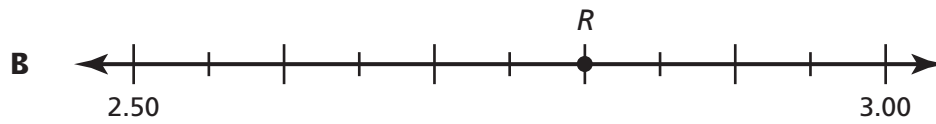
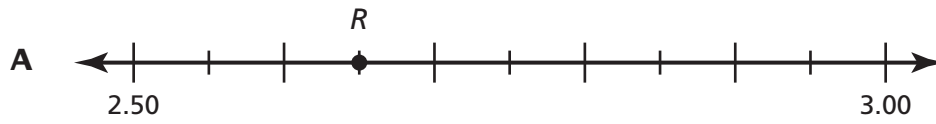

30 Look at the key below.

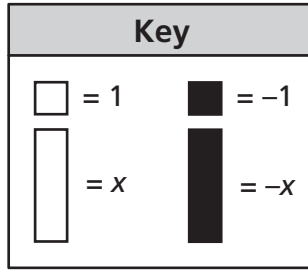

Which expression is represented by this model?



- F** $-3x - 5$
- G** $-3x + 5$
- H** $-5x - 3$
- J** $-5x + 3$

31 Isabella wrote the equation below.

$$34 = 6 + 4c$$

What value of c makes the equation true?

- A** 160
- B** 112
- C** 10
- D** 7

Go On ►

- 32** The measures of two of the exterior angles of a triangle are shown below.

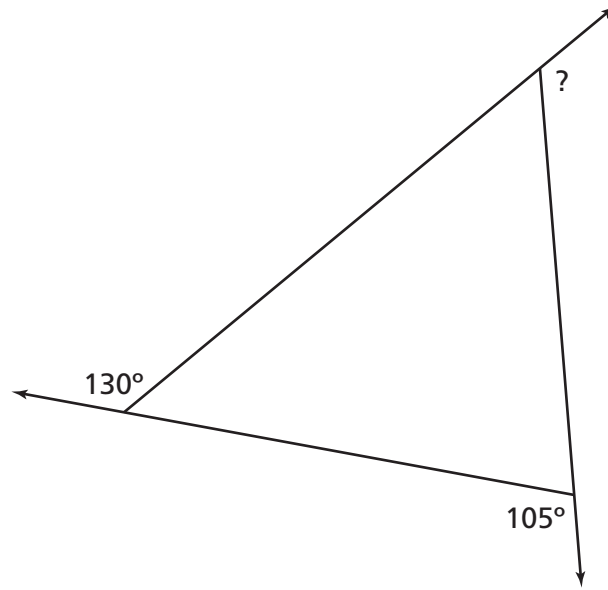

What is the measure of the third exterior angle?

- F** 235°
- G** 125°
- H** 75°
- J** 55°

33 The list below shows the amount of time it will take Tammy to do each of her chores.

- Rake the leaves (20 minutes)
- Clean her room (40 minutes)
- Do the laundry (40 minutes)
- Do her homework (40 minutes)

Which equation could be used to find m , the total number of minutes it will take Tammy to do all the chores on her list?

- A** $m = (40 + 3) \times 20$
- B** $m = (40 \times 3) \times 20$
- C** $m = (40 + 3) + 20$
- D** $m = (40 \times 3) + 20$

34 Which situation is best represented by the integer -12 ?

- F** The length of curtains is increased by 12 inches.
- G** The price of a scooter is reduced by 12 dollars.
- H** The size of a picture is enlarged by 12 percent.
- J** The temperature rises by 12 degrees.

35 Richard has 3 whole pizzas. He will divide these pizzas so that each person receives $\frac{2}{8}$ of a pizza. What is the greatest number of people who can receive $\frac{2}{8}$ of a pizza?

- A** 4
- B** 6
- C** 12
- D** 16

36 Which expression has the same value as $54 - (10 + 18)$?

- F** $54 - 18 + 10$
- G** $54 - (18 + 10)$
- H** $(54 + 10) - 18$
- J** $(54 - 18) + 10$

- 37** The amount of sales in dollars for a company in the first 3 years is shown on the graph.

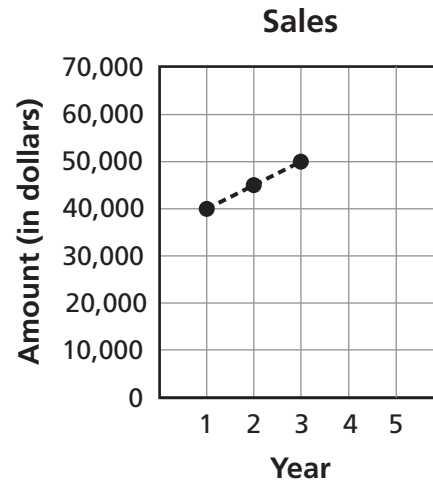

If sales continue to increase as shown, which is the best prediction of the amount the company will have in sales in Years 4 and 5 combined?

- A** less than \$50,000
- B** between \$50,000 and \$60,000
- C** between \$110,000 and \$120,000
- D** more than \$120,000

- 38** Which point on the number line below is closest to $14\frac{7}{12}$?



- F** Point *P*
- G** Point *Q*
- H** Point *R*
- J** Point *S*

Go On ►

39 A newspaper company wants to find out whether people prefer to get their newspapers delivered to their mailboxes or to their front doors. To help get this information, the company will call 200 randomly selected people from the city where the newspapers are delivered and ask them to select their preferred delivery method. Which best explains how to make sure the sample is not biased?

- A** First ask the people how often they read the newspaper.
- B** First ask the people if they are newspaper delivery customers.
- C** First ask the people which section of the newspaper is their favorite.
- D** First ask the people if they plan to continue living in the city for at least a year.

40 On Saturday, Alma made 70% of the sales at a store where she works. The total amount of sales at the store on Saturday was \$910. What was Alma's total amount of sales on Saturday?

- F** \$130
- G** \$273
- H** \$637
- J** \$840

41 Shaneé needs to translate the description below into a math equation.

8 more than twice a number y is the same as the product of 4 and 3

Which equation is a correct translation of the description?

- A** $8 + 2y = 4 \times 3$
- B** $8 + 2y = 4 + 3$
- C** $2y - 8 = 4 \times 3$
- D** $2y - 8 = 4 + 3$

- 42** The midday temperatures in a city for Monday and Tuesday are represented by points on the number line below.

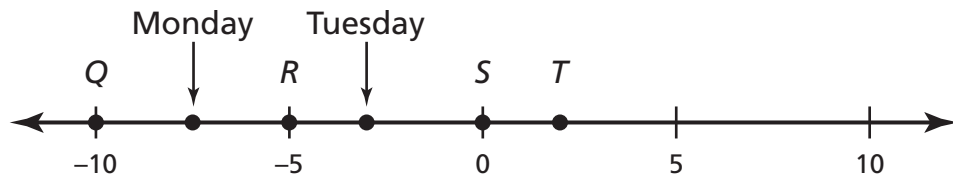

The midday temperature on Wednesday was 2 degrees lower than the midday temperature on Tuesday. Which point best represents the midday temperature on Wednesday?

- F** Point Q
- G** Point R
- H** Point S
- J** Point T

43

The graph shows the number of different types of lawn mowers sold at a garden center in different years.

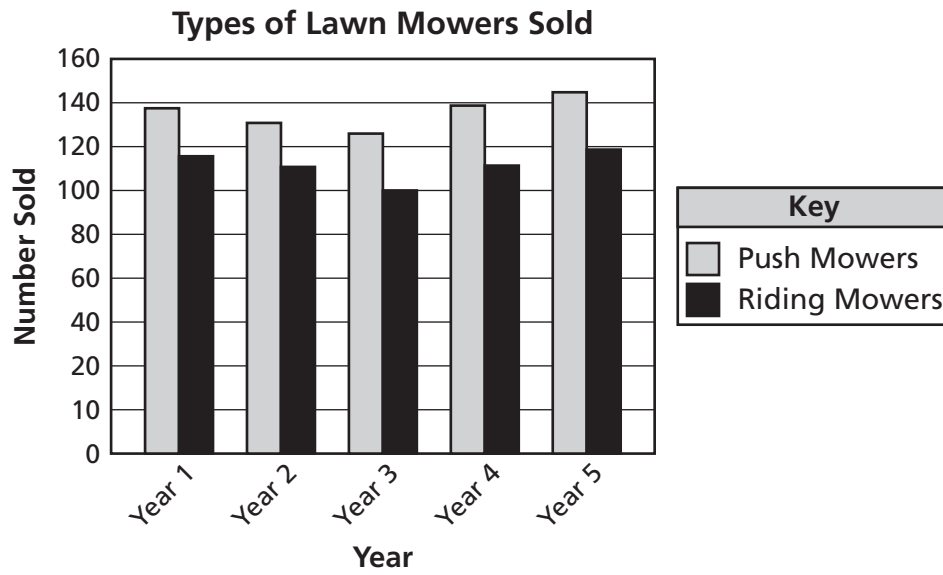

Which feature of this graph may be misleading?

- A** The bars are different heights.
- B** The scale on the vertical axis is not consistent.
- C** The labels on the horizontal axis do not show the actual year.
- D** The information in the key does not match the information on the graph.

44 A house-painting company has $8\frac{1}{4}$ gallons of paint available to paint a house. The paint will be divided equally among 3 painters. How many gallons of paint will each painter receive?

F $2\frac{3}{4}$ gallons

G $5\frac{1}{4}$ gallons

H $11\frac{1}{4}$ gallons

J $24\frac{3}{4}$ gallons

Go On ►

- 45** Roberto swung a rope with a ball tied to the end of it in a circle, as shown below.

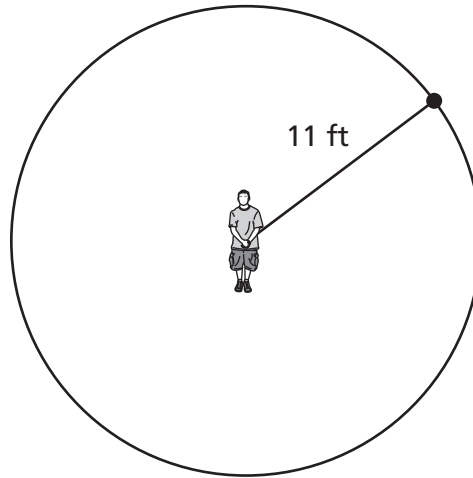

$$A = \pi r^2$$
$$\pi \approx 3.14$$

Which is closest to the area of the circle that Roberto made when he swung the rope?

- A** 1,519.76 ft²
- B** 379.94 ft²
- C** 69.08 ft²
- D** 34.54 ft²

46 Which point is located at $(6, -4)$ on the grid below?

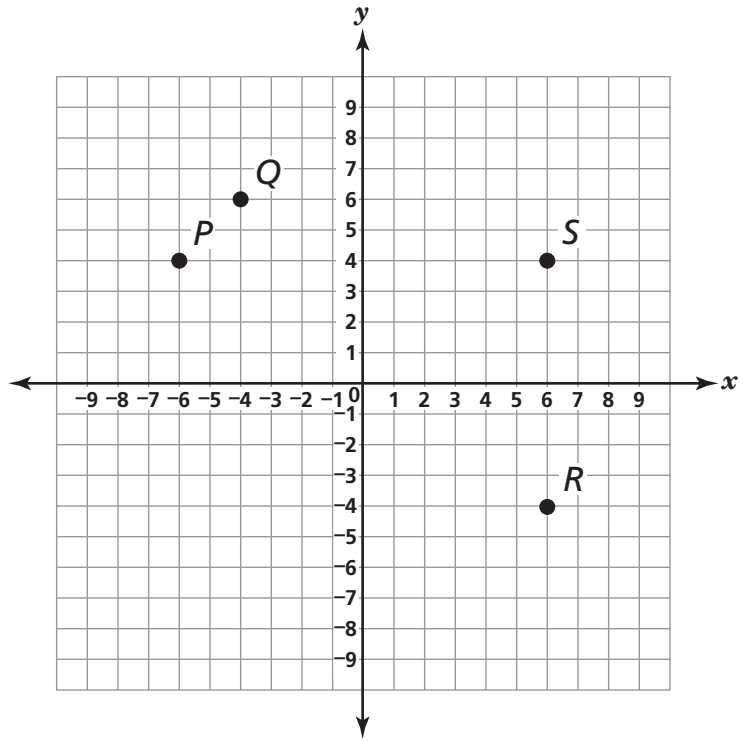

- F** Point *P*
- G** Point *Q*
- H** Point *R*
- J** Point *S*

Go On ►

47 Paola is making batches of spaghetti sauce for a dinner at school. Her recipe uses $1\frac{2}{3}$ pounds of ground meat for each batch of sauce. She started with 27 pounds of ground meat and has already made 3 batches of the sauce. How many more batches of sauce should she be able to make?

- A** 13
- B** 16
- C** 22
- D** 24

48 Which equation represents the commutative property?

- F** $(7 + 3) + 8 = 7 + (3 + 8)$
- G** $5(2 + 3) = (5 \times 2) + (5 \times 3)$
- H** $3 \times 5 = 5 + 5 + 5$
- J** $(7 + 3) + 5 = 5 + (7 + 3)$

49 Which percent is equivalent to $\frac{8}{10}$?

- A** 125%
- B** 80%
- C** 45%
- D** 20%

50 There are 20 students in 4 plays in Mr. Stewart's class, and there are 24 students in 3 plays in Mrs. Rodriguez's class. Based on this information, which statement is true?

- F** The ratio of students in Mr. Stewart's class in plays to students in Mrs. Rodriguez's class in plays is 6:5.
- G** The ratio of students to plays is 5:1 in Mr. Stewart's class and 8:1 in Mrs. Rodriguez's class.
- H** The ratio of students to plays is 1:5 in Mr. Stewart's class and 1:8 in Mrs. Rodriguez's class.
- J** The ratio of plays in Mr. Stewart's class to plays in Mrs. Rodriguez's class is 3:4.

51 A total of 130 letters and 30 packages was mailed at a post office on Saturday. The cost for each letter was between \$0.42 and \$0.68, and the cost for each package was between \$5.55 and \$6.30. Which best represents the total cost for the letters and packages mailed on Saturday?

- A** more than \$300
- B** between \$200 and \$300
- C** between \$100 and \$200
- D** less than \$100

52 The bar graph shows the number of people on a city bus at different times of the day.

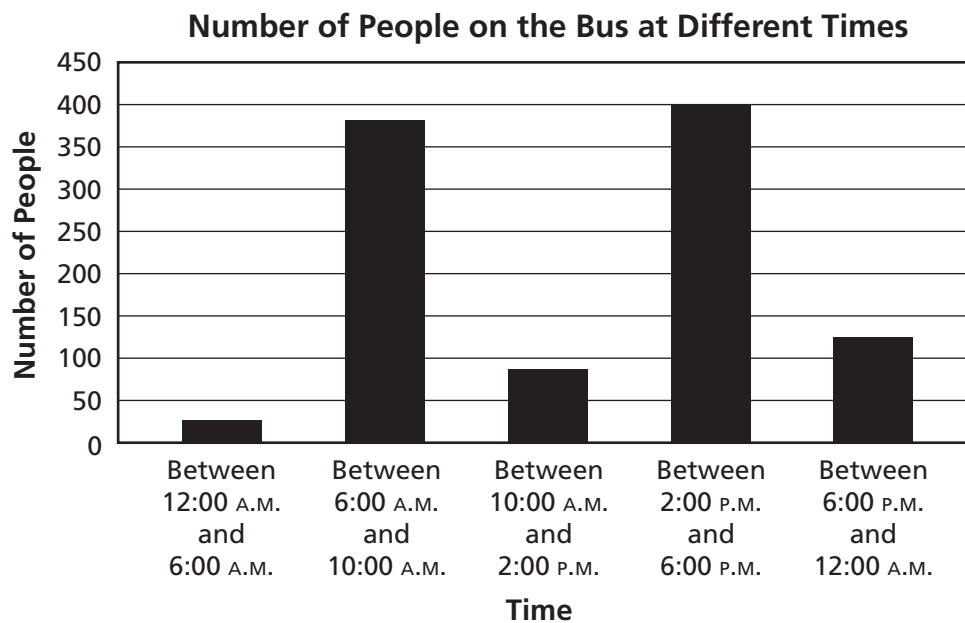

Which feature of this bar graph may be misleading?

- F** The increments on the vertical axis are increasing by 50.
- G** The bars are not in order from largest to smallest.
- H** The scale on the vertical axis is not consistent.
- J** The time increments are not consistent.

53 The librarian had 64 books to deliver to teachers. She delivered 7 of the books and then divided the rest of the books equally into 3 boxes. Which equation could be used to find n , the total number of books she put into each box?

A $n = 64 - (7 \times 3)$

B $n = (64 - 7) \div 3$

C $n = 64 + (7 \times 3)$

D $n = (64 + 7) \div 3$

54 A town mayor wants to know if the residents of a town are in favor of building a new football stadium. On Saturday, he randomly surveyed 50 male residents of the town to see if they were in favor of the new stadium. Which sentence best explains why this sample may be biased?

F The sample was taken on only one day.

G The sample included only males in the survey.

H The sample included residents of only one town.

J The sample did not include all the males in the town.

55 Between noon and 10:00 P.M., Tyrone recorded -18°F as the change in temperature. Which best describes the change in temperature?

A The temperature decreased 18°F by 10:00 P.M.

B The temperature increased 18°F by 10:00 P.M.

C The temperature was -18°F at 10:00 P.M.

D The temperature was 18°F at 10:00 P.M.

STOP 

Mathematics Answer Key

1	D
2	F
3	B
4	H
5	A
6	G
7	D
8	H
9	A
10	F
11	C
12	H
13	B
14	H

15	C
16	H
17	D
18	F
19	A
20	J
21	A
22	J
23	A
24	J
25	C
26	F
27	D
28	H

29	D
30	G
31	D
32	G
33	D
34	G
35	C
36	G
37	C
38	G
39	B
40	H
41	A
42	G

43	B
44	F
45	B
46	H
47	A
48	J
49	B
50	G
51	B
52	J
53	B
54	G
55	A