

VIRGINIA STANDARDS OF LEARNING

Spring 2007 Released Test

GRADE 7 MATHEMATICS

Form M0117, CORE 1

Property of the Virginia Department of Education

©2007 by the Commonwealth of Virginia, Department of Education, P.O. Box 2120, Richmond, Virginia 23218-2120. All rights reserved. Except as permitted by law, this material may not be reproduced or used in any form or by any means, electronic or mechanical, including photocopying or recording, or by any information storage or retrieval system, without written permission from the copyright owner. Commonwealth of Virginia public school educators may reproduce any portion of these released tests for non-commercial educational purposes without requesting permission. All others should direct their written requests to the Virginia Department of Education, Division of Student Assessment and School Improvement, at the above address or by e-mail to Student_Assessment@doe.virginia.gov.

- 1 Harrison is buying a bicycle for \$340. What amount of sales tax must he pay if the sales tax rate is 7%?**
- A** \$7.00
 - B** \$23.80
 - C** \$24.60
 - D** \$238.00
-
- 2 Jack spent 30% of the money he earned mowing lawns last summer. If Jack spent \$45, what was the total amount of money he earned mowing lawns last summer?**
- F** \$15
 - G** \$75
 - H** \$150
 - J** \$195

- 3** Mike is making a scale model of his favorite car. The actual car is 8 feet long and 4 feet wide. Mike wants his model to be 12 inches in length. Which could be used to find the width of his model if he uses the same ratio?

A $\frac{8}{4} = \frac{12}{x}$

B $\frac{8}{4} = \frac{x}{12}$

C $\frac{8}{12} = \frac{x}{4}$

D $\frac{12}{8} = \frac{4}{x}$

- 4** Anita put \$3,000 in a savings account. The account earns an annual interest rate of 3.5%. How much interest will Anita earn after her money has been in the account for one year?

F \$105

G \$350

H \$1,050

J \$2,650

5 Joe knows a 5-pound turkey breast will feed 8 people. If 20 people are coming to Joe's home for dinner, at this rate how many pounds of turkey breast will he need?

- A 7.5 lbs
- B 12.5 lbs
- C 17 lbs
- D 32 lbs

6 A dolphin is 30 feet below the surface of the water. She rises 23 feet, sinks 17 feet, and finally rises another 27 feet. If there are no other changes, the dolphin is —

- F 3 feet above the surface of the water
- G 3 feet below the surface of the water
- H 63 feet above the surface of the water
- J 63 feet below the surface of the water

7 Use the number line to complete the sentence.

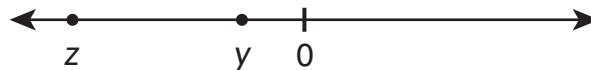

The value of $\frac{y}{z}$ will be —

- A negative because both y and z are negative
- B positive because both y and z are negative
- C negative because z is farther from 0 than y
- D positive because y is closer to 0 than z

8 Which property is shown in the following number sentence?

$$\left(\frac{3}{4}x + 9\right) + 0 = \left(\frac{3}{4}x + 9\right)$$

- F** Multiplicative identity property
- G** Additive identity property
- H** Multiplicative inverse property
- J** Additive inverse property

9 Which statement is *false*?

- A** $-\frac{7}{1} = -1$
- B** $7 \cdot 0 = 0$
- C** $7 + (-7) = 0$
- D** $7 \cdot -1 = -7$

10 Which number is equivalent to 0.7%?

- F** 0.007
- G** 0.07
- H** 7
- J** 70

- 11** Anne's utility bills for three months were \$59, \$67, and \$33. To add the utility bills mentally, Anne thought

$$“(59 + 67) + 33 = 59 + (67 + 33).”$$

What property did Anne use?

- A** Inverse property of addition
- B** Identity property of addition
- C** Commutative property of addition
- D** Associative property of addition

12 $\frac{4}{3} \cdot 9^2 - 2^9 =$

- F** 404
- G** 6
- H** -6
- J** -404

13 Which is correctly written in scientific notation?

- A** 5.6×10^6
- B** 56×10^5
- C** 5,600,000
- D** 56 million

14 Which is true?

- F** $30\% = \frac{3}{100}$
- G** $\frac{3}{50} = 0.06$
- H** $\frac{30}{1,000} = 0.30$
- J** $60\% = \frac{3}{50}$

15 Triangle *MOE* is similar to triangle *SAW*.

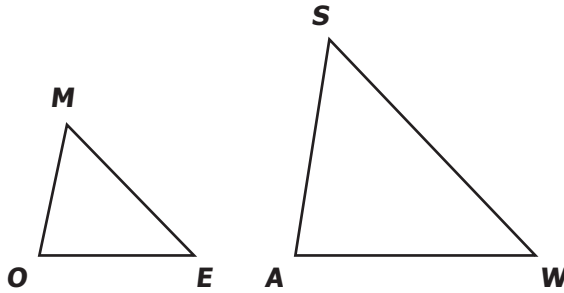

Which *must* be true?

A $\frac{MO}{SA} = \frac{OE}{SW}$

B $\frac{MO}{SA} = \frac{ME}{AW}$

C $\angle MEO \cong \angle SWA$

D $\angle MEO \cong \angle ASW$

16 The ordered pair $(-3, 4)$ is located in which quadrant of a coordinate plane?

F I

G II

H III

J IV

17 Which figure is a decagon?

A

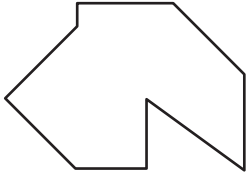

B

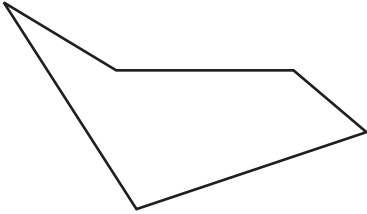

C

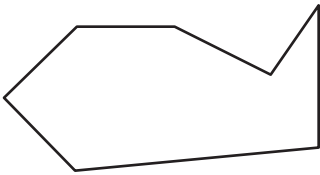

D

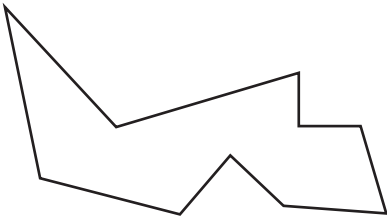

18 Which is a parallelogram with all congruent sides?

- F** Trapezoid
- G** Heptagon
- H** Rhombus
- J** Decagon

19 Look at the coordinate grid.

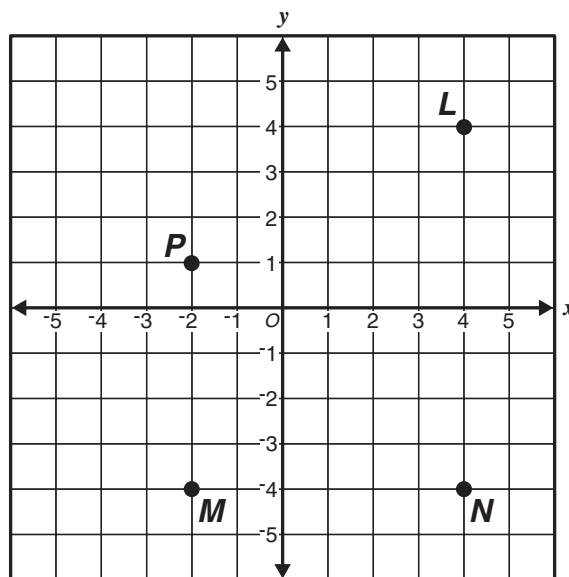

Which point is located in Quadrant II?

- A** *M*
- B** *P*
- C** *L*
- D** *N*

20 Which is most likely *not* a rhombus?

F

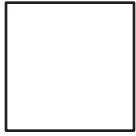

G

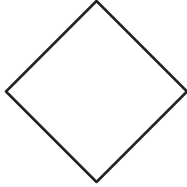

H

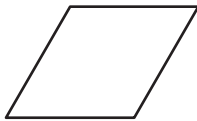

J



21 A cylindrical-shaped water tank has a diameter of 4 feet and is 12 feet tall. Which is closest to the volume of this tank?

- A 48 cubic feet
- B 151 cubic feet
- C 452 cubic feet
- D 603 cubic feet

22 Chelsea wants to cover a rectangular prism-shaped box with paper. Which is closest to the minimum amount of paper Chelsea needs?

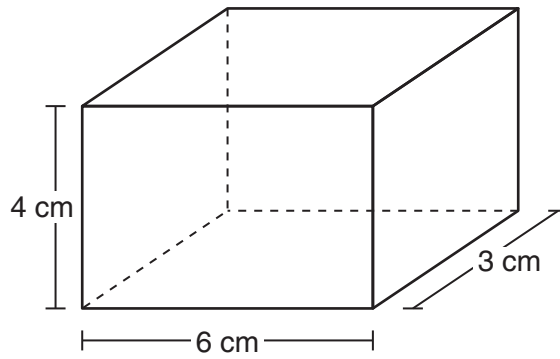

- F** 26 cm²
- G** 54 cm²
- H** 72 cm²
- J** 108 cm²

23 Pablo has a large, circular rug on his square-shaped bedroom floor.

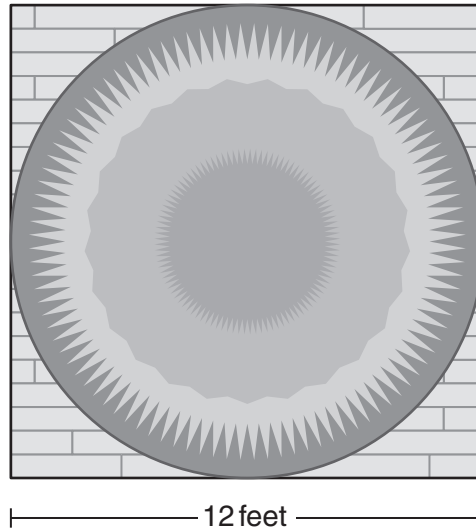

If the diameter of the rug is equal to the length of the bedroom floor, which is closest to the area of the rug?

- A 38 sq ft
- B 75 sq ft
- C 113 sq ft
- D 144 sq ft

24

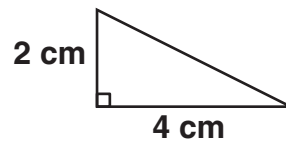

What is the minimum number of same-sized triangles as the one above that would be required to form the polygon below?

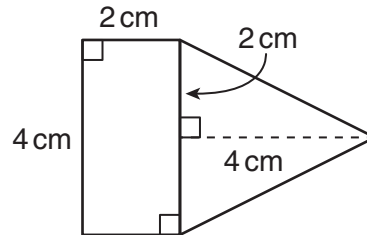

- F 3
- G 4
- H 6
- J 8

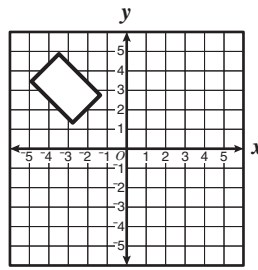

If the figure shown above is rotated 180° *clockwise* about the origin, which best represents the new figure?

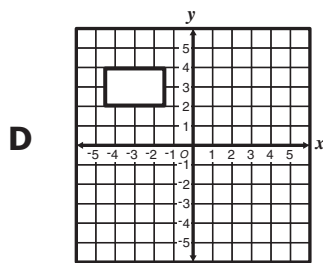
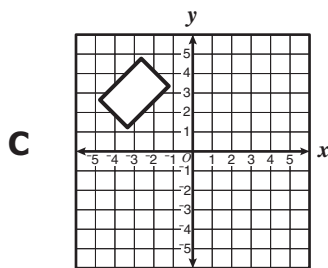
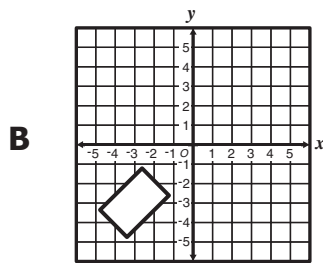
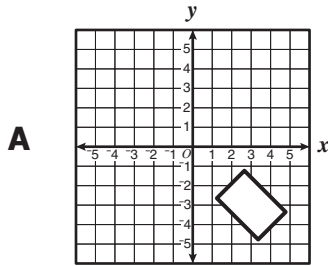

26 What is the area of the parallelogram shown?

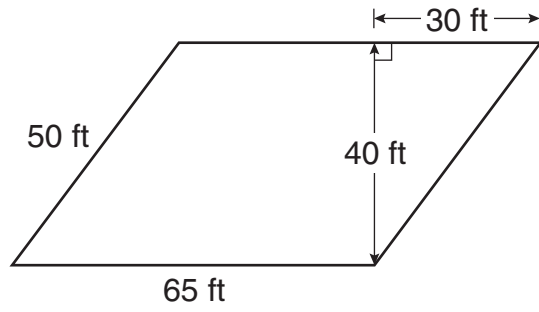

- F 185 sq ft
- G 230 sq ft
- H 2,600 sq ft
- J 3,250 sq ft

27 Look at the table.

**Camp Whitaker
Sandwich Choices**

Type of Bread	Type of Meat	Type of Cheese
White Wheat Rye	Turkey Ham Roast beef Pastrami	American Swiss Provolone

Which is equivalent to the total number of sandwich combinations of 1 type of bread, 1 type of meat, and 1 type of cheese?

- A $3+4+3$
- B 3^2+4
- C $(3\times 4)+(3\times 4)$
- D $3\times 4\times 3$

28 The faces of a fair 6-sided cube are numbered 1 through 6. What is the probability that a 2, 3, or 5 will land face-up on the next roll?

- F $\frac{1}{2}$
- G $\frac{1}{3}$
- H $\frac{1}{5}$
- J $\frac{1}{6}$

29

18, 24, 18, 23, 19, 24, 23, 18

Which measure has the greatest value for the data listed?

- A Mode
- B Mean
- C Range
- D Median

30

**Cheeseburgers Sold
Last Week**

Day	Number
Sunday	59
Monday	34
Tuesday	38
Wednesday	44
Thursday	46
Friday	87
Saturday	92

What is the range of the data?

- F 33
- G 44
- H 58
- J 92

31 Part of the box-and-whisker plot Jim was creating is shown below.

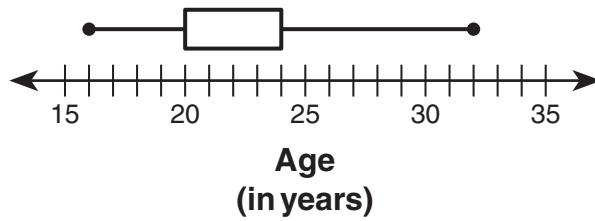

What could be missing from Jim's plot?

- A** Upper extreme
- B** Lower extreme
- C** Upper quartile
- D** Median

32 Mike has attempted 84 free throws. Of those attempted, 63 have gone in the basket. Based on this rate, what is the probability that Mike's next free throw attempt will go in the basket?

F $\frac{1}{4}$

G $\frac{1}{3}$

H $\frac{2}{3}$

J $\frac{3}{4}$

**High Temperatures
for Oakwood City**

Day	Temperature (°F)
Mon.	56
Tue.	59
Wed.	62
Thu.	62
Fri.	61
Sat.	62
Sun.	59

Which is closest to the mean (average) high temperature?

- A** 56°F
- B** 60°F
- C** 61°F
- D** 62°F

34 Jesse has 2 pairs of jeans, 4 sweaters, and 3 pairs of shoes. How many different combinations of a pair of jeans, a sweater, and a pair of shoes does she have?

- F** 8
- G** 9
- H** 12
- J** 24

35 Which of the following is *not* a necessary calculation for constructing a box-and-whisker plot?

- A** Lower extreme
- B** Median
- C** Mean
- D** Upper quartile

36 Freddie has 3 colors of construction paper. He will cut 5 different shapes from each color of construction paper to make a collage. Which is equivalent to the total number of shapes Freddie will cut?

- F** $5 \cdot 3$
- G** $5 + 3$
- H** $5 \cdot 5 \cdot 5$
- J** $3 \cdot 3 \cdot 3 \cdot 3 \cdot 3$

**Beth's Bag of
Same-Sized Balloons**

Color	Number
Red	10
Green	22
Blue	10
Yellow	13

Beth will reach into the bag and randomly choose 1 balloon. What is the probability she will choose a green balloon?

- A** $\frac{1}{3}$
- B** $\frac{2}{5}$
- C** $\frac{3}{5}$
- D** $\frac{2}{3}$

Custom Skateboard Options

Design	Background Color
Wavy lines	Red
Geometric shapes	Black
Solid color	Blue
	Gray

Which tree diagram shows all the possible combinations of custom skateboards with 1 design and 1 background color?

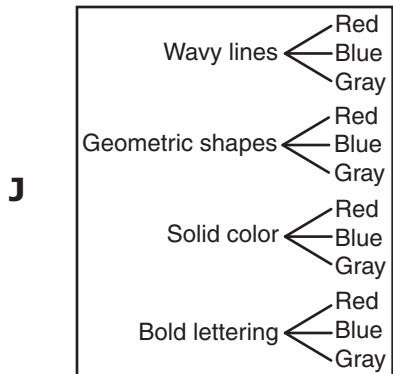
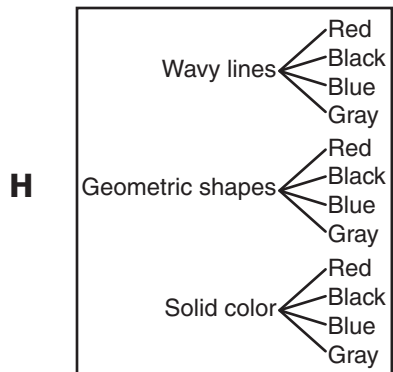
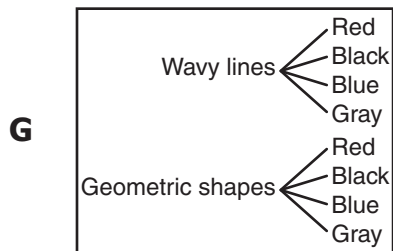
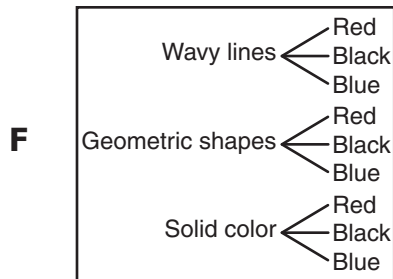

39 What is the value of x for which the following is true?

$$30x = 40$$

- A** $\frac{3}{4}$
- B** $\frac{4}{3}$
- C** 10
- D** 70

40 Which is a value for r that makes the following true?

$$-12 + r > 24$$

- F** -13
- G** 13
- H** -37
- J** 37

41 Which is a value for h that makes the following true?

$$-4h \geq 24$$

- A** -7
- B** 7
- C** -5
- D** 5

42 Which best describes the following?

$$3x + 5x + 11$$

- F** Constant
- G** Expression
- H** Equation
- J** Inequality

43 Tasha read 200 pages in her book this week. This was 50 more pages than she read last week. How many pages did she read last week?

- A** 4
- B** 40
- C** 150
- D** 250

44

x	y
-2	-1
-1.5	0
0	3
3	9

Which is true for all values in the table above?

F $y = -x + 3$

G $y = x - 1$

H $y = x + 1$

J $y = 2x + 3$

45 Which best represents the number sentence shown?

$$x - 7 = 8$$

A Seven less than a number is eight.

B The quotient of x and 7 is eight.

C Seven take away a number is eight.

D A number subtracted from seven is eight.

46 If z stands for the number, which best represents the sentence below?

Forty less than thirty is a number.

F $40 - 30 = z$

G $30 - 40 = z$

H $40 - z < 30$

J $z - 30 < 40$

47 $4x + 4$ _____

Which should be placed on the blank line above to make an inequality?

A $= 12$

B > 12

C -12

D $\div 12$

48 If n stands for the number, which best represents the following phrase?

The sum of a number and five divided by fifteen

F $n + \frac{15}{5}$

G $\frac{15}{n} + 5$

H $\frac{15}{(n+5)}$

J $\frac{(n+5)}{15}$

49 Ginni wrote the following geometric sequence in her notebook.

3, 9, 27, 81, 243, 729, . . .

What would be the 8th term in Ginni's sequence?

A 1,458

B 2,187

C 5,832

D 6,561

50 Which table contains *only* values that make the following true?

$$y = 2x + 7$$

F

x	y
0	7
1	9
2	11

G

x	y
1	9
3	6
5	10

H

x	y
1	7
2	14
3	21

J

x	y
-2	3
0	0
2	-3



Answer Key-7074-M0117

Test Sequence Number	Correct Answer	Reporting Category	Reporting Category Description
1	B	002	Computation and Estimation
2	H	002	Computation and Estimation
3	A	002	Computation and Estimation
4	F	002	Computation and Estimation
5	B	002	Computation and Estimation
6	F	002	Computation and Estimation
7	B	002	Computation and Estimation
8	G	001	Number and Number Sense
9	A	001	Number and Number Sense
10	F	001	Number and Number Sense
11	D	001	Number and Number Sense
12	J	001	Number and Number Sense
13	A	001	Number and Number Sense
14	G	001	Number and Number Sense
15	C	003	Measurement and Geometry
16	G	003	Measurement and Geometry
17	D	003	Measurement and Geometry
18	H	003	Measurement and Geometry
19	B	003	Measurement and Geometry
20	J	003	Measurement and Geometry
21	B	003	Measurement and Geometry
22	J	003	Measurement and Geometry
23	C	003	Measurement and Geometry
24	G	003	Measurement and Geometry
25	A	003	Measurement and Geometry
26	H	003	Measurement and Geometry
27	D	004	Probability and Statistics
28	F	004	Probability and Statistics
29	D	004	Probability and Statistics
30	H	004	Probability and Statistics
31	D	004	Probability and Statistics
32	J	004	Probability and Statistics
33	B	004	Probability and Statistics
34	J	004	Probability and Statistics
35	C	004	Probability and Statistics
36	F	004	Probability and Statistics
37	B	004	Probability and Statistics
38	H	004	Probability and Statistics
39	B	005	Patterns, Functions, and Algebra
40	J	005	Patterns, Functions, and Algebra
41	A	005	Patterns, Functions, and Algebra
42	G	005	Patterns, Functions, and Algebra
43	C	005	Patterns, Functions, and Algebra
44	J	005	Patterns, Functions, and Algebra
45	A	005	Patterns, Functions, and Algebra
46	G	005	Patterns, Functions, and Algebra
47	B	005	Patterns, Functions, and Algebra
48	J	005	Patterns, Functions, and Algebra
49	D	005	Patterns, Functions, and Algebra
50	F	005	Patterns, Functions, and Algebra